



2021

Catalogue

cement bonded particle board BetonWood

Beton  **Wood**[®]

Index

general	• introduction to cement bonded particle board	pg. 4
	• application areas	pg. 5
	• BetonWood® product overview	pg. 6
	• overview of BetonWood® coupled products	pg. 8
	• ecological qualities and the certifications obtained	pg.12
	• environmental product declaration of BetonWood®	pg.14
	• cement bonded particle board's characteristics	pg.20
products	Cement bonded particle board BetonWood® products:	
	• BetonWood® density 1350 kg/m ³ - cement bonded particle boards	pg.26
	• BetonWood® N density 1350 kg/m ³ - small size cement bonded particle boards	pg.30
	• BetonWood® sanded density 1350 kg/m ³ - sanded cement bonded particle boards	pg.33
	• BetonWood® tongue&groove density 1350 kg/m ³ - cement bonded particle board with interlocking edges	pg.35
characteristics	• special processing	pg.37
	• storage & transport	pg.38
	• acoustic insulation	pg.39
	• general properties of resistance	pg.40
	• loading capacity	pg.43
	• resistance to insects and fungi	pg.44
• resistance to atmospheric agents	pg.44	
fixing & processing	• nails fixing on BetonWood® boards	pg.45
	• screws fixing on BetonWood® boards	pg.45
	• processing and fixing of BetonWood® boards	pg.46
	• joints formation	pg.49
	• panels drilling	pg.51
	• finishing and painting	pg.51
building solution	• BetonWood® fixed on metal frame structures	pg.52
	• BetonWood® fixed on wood frame structures	pg.53
	• BetonWood® to make dry screeds	pg.54
	• BetonWood® fixed on galvanised corrugated metal sheet	pg.55
	• BetonWood® to make roof systems	pg.56
	• BetonWood® to make wall systems	pg.57
	• BetonWood® to make radiant heating systems	pg.58
	• BetonWood® to make exhibitions	pg.59
	• Notes	pg.60



Introduction to **cement bonded particle boards**

BetonWood® s.r.l. produces and sells high density and high mechanical resistance insulating panels.

The **BetonWood®** cement bonded particle board construction panel combines the advantageous properties of stiffness and resistance of cement with the insulating properties of wood fibers and the workability of wood; precisely for this reason it is a material that is suitable for multiple uses in construction.

It is made of high-density Portland cement and debarked pine wood fibers and uses water and salt as binders; guarantees an excellent solution for interventions aimed at obtaining high levels of thermal displacement, thanks to its high density which also makes it suitable for self-supporting dry screeds, radiant floors and stiffening structures.

The surfaces are smooth and concrete gray; in the case of **BetonWood® Sanded**, the surfaces are subjected to a sanding and calibration treatment to bring out the wood fibers on the surface and give the panel less tolerance and a more “interesting” architectural appearance.

BetonWood® panels are lighter than traditional building materials and are resistant to climate change and frost. Insects and fungi are unable to attack or damage it.

Thanks to its physical and mechanical characteristics, the product is considered one of the best materials for light constructions.

The product is eco-sustainable and bio-compatible, unlike other competing panels such as OSB panels with a high presence of formaldehyde that is released in environments in the form of volatile aldehydes (VOC), highly carcinogenic emissions for a period of 24 years.

It is guaranteed by constant checks carried out by external bodies which certify its high quality and, thanks to its high percentage of recycled material (**35%**), it fully complies with the **Minimum Environmental Criteria** and is **CAM** certified.

The fire resistance class and suitability for escape routes is guaranteed by the European standard 2003/43/EC - standard EN 13501-2. **BetonWood®** is therefore fire certified with the new European CE classes in class A2fl-s1, moreover the European standardization EN 13501-2 has also been implemented by the Italian state with the D.L. 16 Feb 2007.

For more information contact our **technical department** at info@betonwood.com.

Main properties of **BetonWood®** building panels:

- fireproof (A2-fl-s1 class according to DIN 13501-2)
- CE certified
- resistant to atmospheric agents
- waterproof
- resistant to fungi, molds, insects
- unassailable by animals, rodents, termites, etc.
- free from formadeide and asbestos
- free from recycled inks
- anti-freeze
- workable with woodworking tools
- high density
- high mechanical resistance
- resistant to vandalism
- harmless to humans and the environment



Application areas

BetonWood® has been used in Europe since 1977 starting from the Eastern markets, where it has been used over the years, first as a structural panel for wooden houses and then gradually expanding its uses in the construction and interior design sectors. **BetonWood®** panels have multiple uses, in particular they can be used in:

- wood / metal and prefabricated buildings
- thermal and acoustic insulation / insulation
- external and internal thermal coats
- ventilated roofs
- radiant floors
- exhibition stands, installations in general
- raised floors
- materials for bio-ecological building
- dividing walls
- high resistance counter-walls
- fireproof walls and fire doors
- platforms and slides
- systems with high thermal displacement
- high-capacity mezzanines and attics
- false ceilings
- fireproof coatings
- road and railway noise barriers
- disposable formworks
- playpen for animals, etc.

To inquire about the application of the **BetonWood®** panel in other sectors not listed therein, please contact our technical department at info@betonwood.com.

BetonWood® construction panels can be used in the building sector by replacing wooden panels and are a valid alternative to materials such as plasterboard, Eraclit, Celenit, Calcium Sulphate, Legnomagnesite, MDF, OSB, plywood and chipboard. The areas of use of **BetonWood®** are numerous:

- public and private buildings
- commercial buildings
- education buildings
- public health buildings
- trade fair events
- prefabricated
- public and private furnishings
- entertainment centers
- wooden houses
- country houses
- stores

The application of the panels and the construction structure vary according to the individual design. It is necessary to take into account the physical, mechanical and thermodynamic characteristics of the **BetonWood®** building boards and the principles of building construction.



Cement bonded particle board **BetonWood**[®]

The high-density constructive panel, a strength champion and ideal for being applied to all parts of the building, be they external or internal.

With this type of panel BetonWood srl has developed original coupled products that are excellent for thermal insulation systems with high mechanical resistance, dry insulating screeds, roofs with high thermal displacement, floor or wall systems with radiant heating.

BetonWood[®] is a panel made of wood fibers uniformly agglomerated with Portland type cement; its surface is smooth and gray in color like natural concrete. The **BetonWood**[®] cement bonded particle board is produced by pressing a mixture of debarked pine wood fibers (63% by volume), Portland cement (25% by volume), Water (10% by volume) and hydration additives (2% by volume) .

The **BetonWood**[®] cement bonded particle board is mainly used as a building material in case resistance to humidity, strength, fire resistance, eco-sustainability and resistance to compression and impact are required at the same time.

BetonWood[®] panels contain neither asbestos nor formaldehyde; they are resistant to insects and mice and are resistant to mold. They are flame retardant and can provide sound insulation. In addition, they have the advantage that they can be worked with traditional woodworking tools.



Figure 1 Sample of our standard cement bonded particle board **BetonWood**[®]

BetonWood®

Density 1350 kg/m³



pg.26

BetonWood® represent the standard product. It is realized with high density cement bonded particle board (1350 Kg/m³), it guarantees an excellent solution to obtain high levels of thermal displacement. It is suitable for dry screeds, roofs, floors, counter walls and fittings.

BetonWood® N

Density 1350 kg/m³



pg.30

BetonWood® N is realized with high density cement bonded particle board (1350 Kg/m³) and high compressive strength. It is suitable for dry screeds, roofs, floors, counter walls and fittings. It is smaller and more manageable than **BetonWood®**.

BetonWood® sanded

Density 1350 kg/m³



pg.33

BetonWood® sanded is realized with high density cement bonded particle board (1350 Kg/m³) and high compressive strength. It is suitable for all parts of the building but it is recommended to install it exposed. It is distinguished by the special surface smoothing that makes the wood emerge from the concrete.

BetonWood® tongue&groove

Density 1350 kg/m³



BetonWood® tongue&groove is realized with high density cement bonded particle board (1350 Kg/m³) and high compressive strength. It is suitable for traditional and raised dry screeds due to its tongue & groove profile which makes it possible to perfectly fit the panels.

BetonWood® tongue&groove sanded

Density 1350 kg/m³



BetonWood® tongue&groove sanded is realized with high density cement bonded particle board (1350 Kg/m³) and high compressive strength. It is the result of the union between **BetonWood® sanded** and **tongue&groove**, therefore it has both a sanded surface and an interlocking tongue&groove profile.

Coupled **BetonWood**[®]

Betonfiber

Coupled BetonWood + Fibertherm



Coupled insulating panels with cement bonded particle board BetonWood and wood fiber Fibertherm density 160kg/m³.

Betonfiber base/dry

Coupled BetonWood + other Fibertherms



Coupled insulating panels with cement bonded particle board BetonWood and wood fiber Fibertherm base or dry.

Betoncork

Coupled BetonWood + CorkPanels



Coupled insulating panels with cement bonded particle board BetonWood and blond cork ideal for humid environments.

Betonstyr EPS

Coupled BetonWood + polystyrene EPS

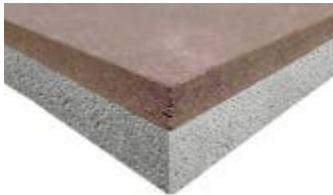

Coupled insulating panels with cement bonded particle board BetonWood and expanded polystyrene with a compression strength of 70kPa.

Betonstyr XPS

Coupled BetonWood + polystyrene XPS



Coupled insulating panels with cement bonded particle board BetonWood and extruded polystyrene with a compression strength of 300kPa.

Betonstrong

Coupled BetonWood + polystyrene Strong



Coupled insulating panels with cement bonded particle board BetonWood and extruded polystyrene with a compression strength of 700kPa.

Sandwich **BetonWall**

Betonwall fiber

Sandwich BetonWood + Fibertherm



Sandwich panels with cement bonded particle board BetonWood and wood fiber Fibertherm density 160kg/m³.

Betonwall fiber base/dry

Sandwich BetonWood + other Fibertherms



Sandwich panels with cement bonded particle board BetonWood and wood fiber Fibertherm base or dry.

Betonwall cork

Sandwich BetonWood + CorkPanels



Sandwich panels with cement bonded particle board BetonWood and blond cork ideal for humid environments.

Betonwall styr EPS

Sandwich BetonWood + polystyrene EPS

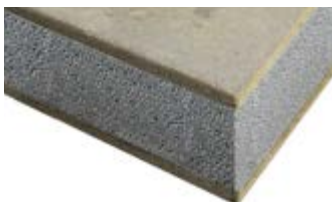

Sandwich panels with cement bonded particle board BetonWood and expanded polystyrene with a compression strength of 70kPa.

Betonwall styr XPS

Sandwich BetonWood + polystyrene XPS



Sandwich panels with cement bonded particle board BetonWood and extruded polystyrene with a compression strength of 300kPa.

Betonwall strong

Sandwich BetonWood + polystyrene Strong



Sandwich panels with cement bonded particle board BetonWood and extruded polystyrene with a compression strength of 700kPa.

Betontherm fiber

System BetonWood + Fibertherm

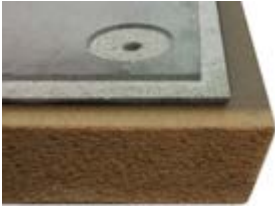

Reinforced insulating composite system with cement bonded particle board BetonWood and wood fiber Fibertherm.

Betontherm fiber base/dry

System BetonWood + other Fibertherms



Reinforced insulating composite system with cement bonded particle board BetonWood and wood fiber Fibertherm base/dry.

Betontherm cork

System BetonWood + CorkPanels



Reinforced insulating composite system with cement bonded particle board BetonWood and blond natural cork.

Betontherm styr EPS

System BetonWood + polystyrene EPS

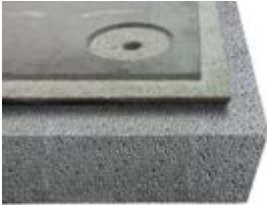

Reinforced insulating composite system with cement bonded particle board BetonWood and expanded polystyrene with a compression strength of 70kPa.

Betontherm styr XPS

System BetonWood + polystyrene XPS

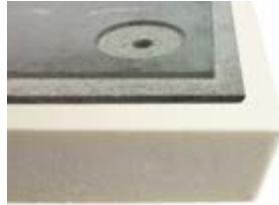

Reinforced insulating composite system with cement bonded particle board BetonWood and extruded polystyrene with a compression strength of 300kPa.

Betontherm strong

System BetonWood + polystyrene Strong

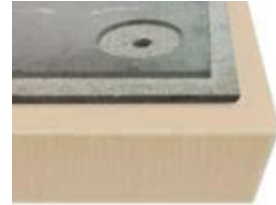

Reinforced insulating composite system with cement bonded particle board BetonWood and extruded polystyrene with a compression strength of 700kPa.

Radiant systems BetonRadiant

Betonradiant

Radiant with BetonWood



Modular radiant heating system with cement bonded particle board BetonWood.

Betonradiant fiber

Radiant BetonWood + Fibertherm



Modular radiant heating system with cement bonded particle board BetonWood and wood fiber Fibertherm.

Betonradiant cork

Radiant BetonWood + CorkPanels



Modular radiant heating system with cement bonded particle board BetonWood and blond natural cork.

Betonradiant styr EPS

Radiant BetonWood + polystyrene EPS



Modular radiant heating system with cement bonded particle board BetonWood and expanded polystyrene EPS.

Betonradiant styr XPS

Radiant BetonWood + polystyrene XPS



Modular radiant heating system with cement bonded particle board BetonWood and extruded polystyrene XPS.

Betonradiant strong

Radiante BetonWood® + polistirene Strong



Modular radiant heating system with cement bonded particle board BetonWood and extruded polystyrene Strong.



CAM certified cement bonded particle board

to obtain the SUPERBONUS 110%

The Relaunch Decree n. 34 of 19 May 2020, as part of the works for the energy redevelopment of existing buildings (superbonus 110%), introduced environmental sustainability requirements on insulating materials (for external thermal insulation of the opaque building envelope: walls, attics, roofs). These requirements are indicated in the CAM Minimum Environmental Criteria, introduced for public tenders in the building sector with the Ministerial Decree of 11 October 2017.



The goal of thermal insulation is to reduce the consumption of energy resources necessary for heating and cooling buildings, reducing atmospheric pollution due to the emission of polluting gases resulting from the combustion processes of energy sources of fossil origin.

Aware that construction is responsible for 40% of total greenhouse gas emissions into the atmosphere, energy efficiency is the European priority in the fight against climate change. Therefore, even the materials necessary for energy saving must be considered for their environmental impact, energy consumption and social costs, in their entire life cycle.

The importance of the EPD

Environmental Product Declaration

The designer must make technical design choices that make it possible to meet the criterion and must prescribe that in the procurement phase the contractor must ensure compliance with the criterion. The percentage of recycled material must be demonstrated through one of the following options:

- an Environmental Product Declaration of Type III, compliant with the UNI EN 15804 standard and the ISO 14025 standard, such as EPDItaly® or equivalent;
- a product certification issued by a conformity assessment body certifying the recycled content through the clarification of the mass balance, such as ReMade in Italy®, Plastic Second Life or equivalent;
- a product certification issued by a conformity assessment body that certifies the recycled content through the clarification of the mass balance which consists in the verification of a self-declared environmental declaration, compliant with ISO 14021.





Attention to the Environment

At **BetonWood**, we are proud of the environmental role we play in the overall cement bonded particle supply chain. By producing wood-based panels using waste wood from the sawmill industry, we help ensure that timber is valued as a limited raw material. We aim to get the maximum possible yield from our products. The result is economic production with the lowest possible environmental impact.

Together with our suppliers, we are committed to achieving the lowest possible environmental impact.

- We make sure that as little waste as possible enters the water, soil and air.
- We promote the recycling of the largest possible amount of waste materials and accelerate the recycling of wood waste.
- We manage, use, store and destroy chemicals with healthy and environmentally safe means.

BetonWood guarantees that our products are not made with wood from national parks, nature reserves, virgin forests and other protected areas; a wood certified "Forest Stewardship Council"® (FSC®), PEFC™, with CE mark.

The certifications of our **BetonWood**® cement bonded particle board are shown on the following pages.

FSC® certification

"Forest Stewardship Council"®

The "Forest Stewardship Council"® (FSC®) is an international NGO that has created an internationally recognized forest certification system. The certification has as its purpose the correct forest management and the traceability of derived products.

The "Forest Stewardship Council"® (FSC®) mark indicates that the wood used to manufacture a certified product comes from a forest that is properly managed according to rigorous environmental, social and economic standards. The forest of origin has been independently controlled and assessed in accordance with the principles and criteria for forest management established and approved by the "Forest Stewardship Council"®.

The FSC® trademarks can be used both on products composed of forest-based material and on promotional material. Only certified companies can use FSC® labels on their products. Any company wishing to use FSC® labels on the products it manufactures must therefore first have obtained Chain of Custody (CoC) certification.





BetonWood®

PEFC™ certification

“Programme for Endorsement of Forest Certification”™

The PEFC™ is an association that constitutes the national governing body of the PEFC™ certification system (Program for Endorsement of Forest Certification schemes), ie the Evaluation Program of forest certification schemes.

The PEFC™ is an international initiative based on a broad understanding of the parties involved in the implementation of sustainable forest management at national and regional level. Representatives of forest owners and poplar groves, end consumers, users, freelancers, the world of the wood industry and crafts participate in the development of PEFC™. Its objectives include improving the image of silviculture and the forest-wood supply chain, effectively providing a market tool that allows the marketing of wood and forest products deriving from forests and plants managed in a sustainable way.

PEFC™ is your guarantee that the woody raw material for paper and wood products comes from sustainably managed forests. Certified forests are checked by independent inspectors.



CARB certification

“California Air Resources Board”

The California Air Resources Board (CARB) imposes some of the most stringent controls in the world regarding air quality and the reduction of pollutants. The agency’s management extends from the automotive industry to the manufacturing of consumer products and, by rewarding sustainable producers and placing strong constraints on those who do not meet CARB standards, set the global precedent for ecological production.

BetonWood srl constantly works to provide products with the best production processes, the best raw materials, raw materials and products with minimized emissions. The recognition of the CARB certification for the production of cement bonded particle boards is the confirmation that the research carried out by **BetonWood®** has paid off.

As a result, **BetonWood srl** is proud to confirm that all **BetonWood®** cement bonded particle products comply with the very low emission E-LE CARB II standard. Since 2015 we have been delivering cement bonded particle boards only in E-LE quality.





Beton Wood®

ISO14001 certification

“Environmental Management System”



The ISO 14001 standard establishes the generic requirements of an environmental management system. Regardless of the type and size of the organization, the requirements of an environmental management system do not change. It is in this sense that the ISO 14001 standard offers a comprehensive approach to the strategic environmental choices of a company. What ISO 14001 requires is the commitment to comply with the mandatory requirements of current legislation, together with the commitment to continuous improvement.

An environmental management system that complies with the requirements of ISO 14001 is a management tool that allows the organization to identify and control its environmental impacts, to continuously improve environmental performance and to implement a systemic approach in defining important objectives and targets. environmental.

By obtaining this certification, **BetonWood srl** is committed to working in compliance with all environmental regulations and instructions.

Fire resistance certification

LAPI is a private laboratory that has been operating since 1983 in the sector of industrial analysis and testing. Specialized in fire behavior tests (where he occupies a position of absolute importance at a European level) LAPI has for some time undertaken analysis in other sectors, while maintaining its identity as a fire testing laboratory.

LAPI operates as a certification and inspection body with the authorization of the Ministries and on the basis of the notification for the Directives indicated. The checks are carried out in accordance with the procedures of EN ISO IEC 17020-EN 45011.

In 2015 LAPI SpA obtained accreditation as a Certification Body for Products, Processes and Services according to the UNI EN ISO IEC 17065: 2012 standard by ACCREDIA (No. PRD 241B). This accreditation provides the guarantee that the LAPI Quality System guarantees compliance with the requirements of competence, consistency and impartiality of the certification bodies of products, processes and services.

We are proud to declare that our BetonWood cement bonded particle products have obtained fire resistance certification in class A2fl-s1.





Environmental Product Declaration

Below is the **Environmental Product Declaration** (or **EPD**) of the **BetonWood®** cement bonded particle wood product. For information about Environmental Declarations of our other products product please click on the following link: [Minimum Environmental Criteria](#) or, you can contact our technical office info@betonwood.com.

1. Product

1.1. Description

BetonWood® is a panel made of wood fibers uniformly agglomerated with Portland type cement; its surface is smooth and gray like natural concrete. The cement bonded particle board **BetonWood®** is processed by pressing a mixture of debarked Pine wood (63% in volume), Portland concrete (25% vol.), water (10% vol) and hydration additives (2% vol).

1.2. Variations and characteristics

The **BetonWood®** cement bonded particle boards are also available in version:

- **N** (small dimensioned boards)
- **Sanded** (with smooth surface)
- **Tongue&Groove** (with interlocking edges)
- **Tongue&Groove Sanded** (with interlocking edges and smooth surface)
- **N Sanded** (small dimension and smooth surface)
- **N Tongue&Groove** (small dimension and interlocking edges)
- **N Tongue&Groove Sanded** (small dimension, interlocking edges and smooth surfaces).

These variants of the standard panel have available sizes and thicknesses that differ from those just listed. To view them, please download the **Environmental Product Declarations** specific for these products.

The **BetonWood®** cement bonded particle boards is mainly used as a construction material when moisture resistance, strength, fire resistance, eco-sustainability and resistance to compression and impact are required at the same time.

The **BetonWood®** cement bonded particle boards contain neither asbestos nor formaldehyde; they are resistant to insects and mice and are resistant to mold. They are flame retardant and can provide sound insulation.

In addition, they have the advantage that they can be worked with traditional woodworking tools.

1.3. Applications

BetonWood® cement bonded particle boards are structural elements used for internal or external dry or wet applications. They cannot be classified as "structural" materials if used in a thickness below 16 mm.

BetonWood® can be used alone or combined with other insulating materials, so as to provide a perfect response to the most varied construction needs.

Used as a construction panel it is suitable for:

- ✓ BetonRadiant radiant floors and pre-reinforced floors;
- ✓ roofs with high thermal displacement;
- ✓ ceilings, counterblocks and fire-resistant walls;
- ✓ fireproof walls;
- ✓ self-supporting and sound-absorbing walls;
- ✓ structure for floors and raised floors;
- ✓ load support for floor and walls;
- ✓ partition walls for offices;
- ✓ thermal insulating systems BetonTherm;
- ✓ vandal-proof protective coatings;
- ✓ traditional and raised floors on adjustable supports;
- ✓ modular systems for prefabricated floors;
- ✓ building material in health facilities;
- ✓ counter wall for gyms;
- ✓ shop fittings;
- ✓ fixtures;



Beton Wood®

- ✓ external and internal coatings;
- ✓ platforms for counters, platforms and slides;
- ✓ exhibition stands and prefabricated boxes;
- ✓ road and railway noise barriers;

✓ disposable formwork.
and much more..

For more information, please send an email to: info@betonwood.com

2. System boundary and production process

Reference service life:	The reference service life is the same as the building.
Time representativeness:	Specific data about the manufacturer were based on the 1-year average (the reference year 2019). Time scope less than 10-years were applied for background data.
Cut off rules:	The cut-off criterion was chosen based on the used PCR. According to the used PCR, more than 95% of flows were included.
Database(s) and LCA software used:	GaBi software, GaBi database and EcolInvent database
Allocations:	As a general allocation rule, allocation on 1 m ³ of the product was chosen. No secondary material and/or fuels used in production.
Geographical scope:	Europe, Global

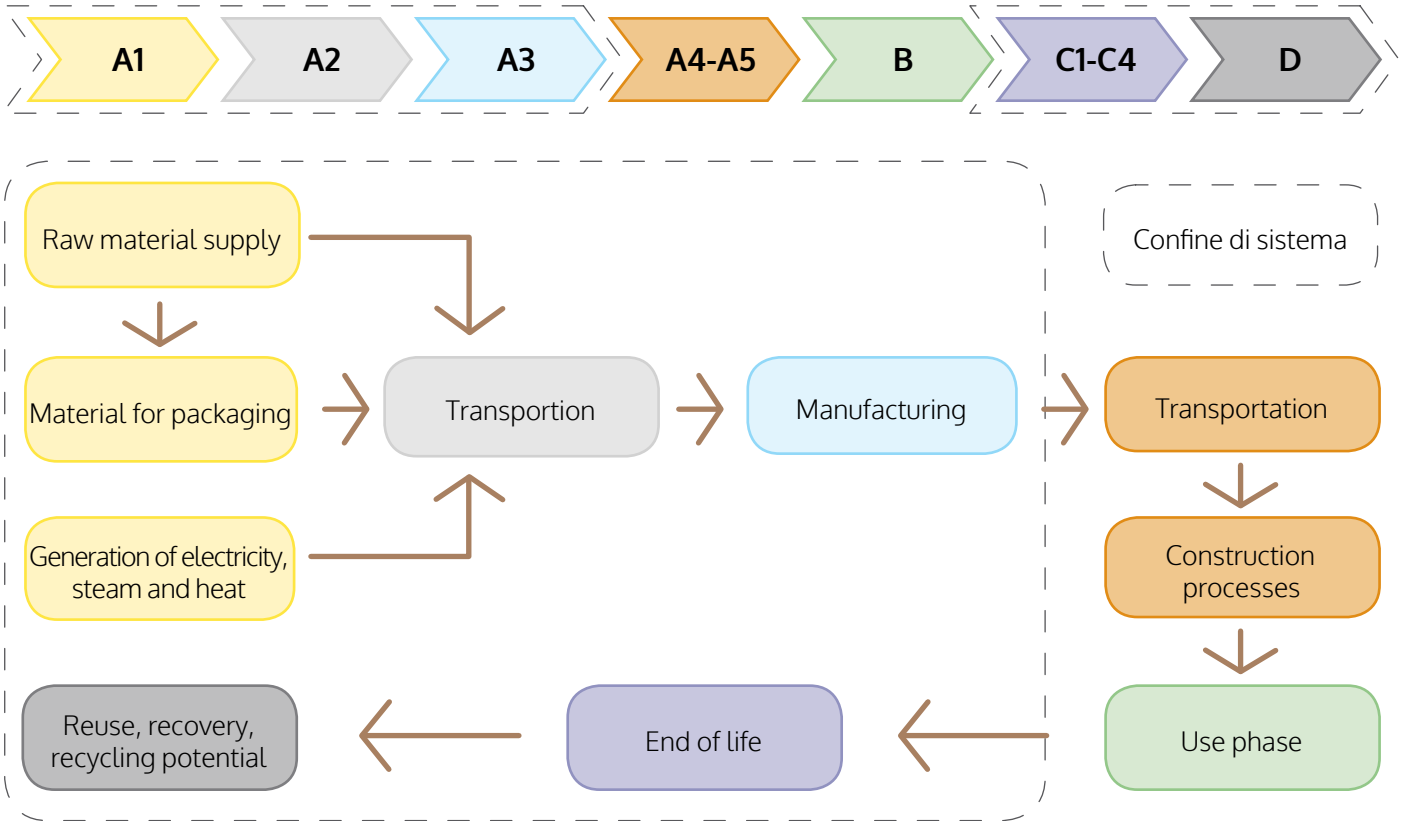

Figure 2 System Boundary of the LCA study conducted on **BetonWood®**, a.s cement-bonded particle board



Beton Wood®

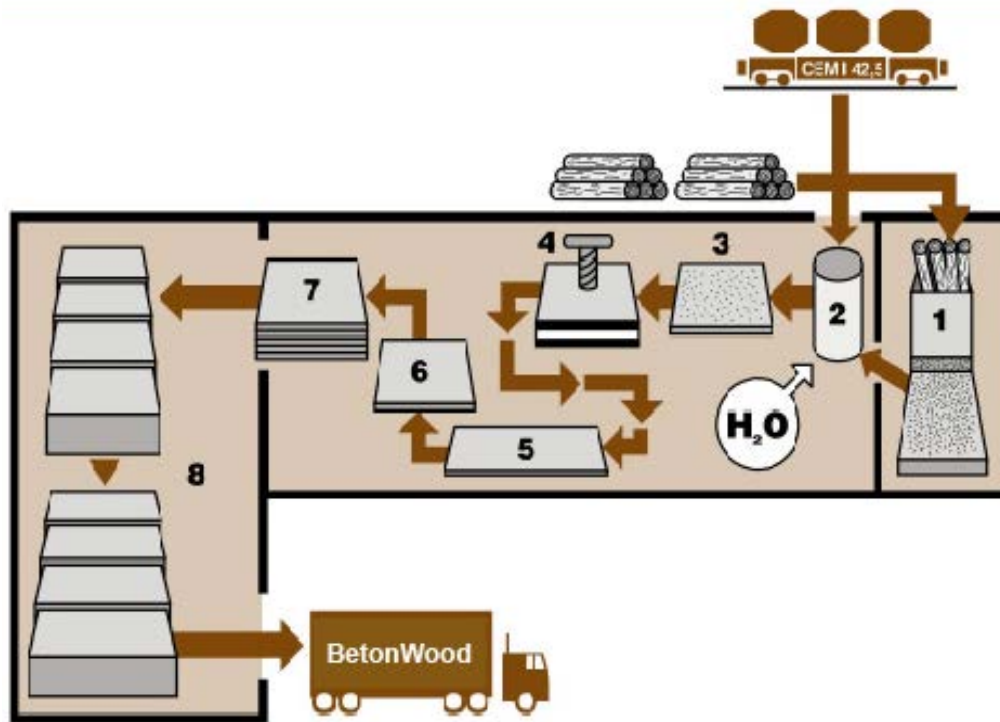

Figure 3 Production flow-chart of **BetonWood®**, a.s cement-bonded particle board:
 1 spilling;
 2 preparation of mixture;
 3 layering of boards;
 4 pressing;
 5 drying;
 6 formatting;
 7 storage;
 8 transport.

3. LCA: results

Description of the system boundary

(X=included in LCA; MND= Module Not Declared)

Product stage			Construction process		Use stage								End of life stage				Benefits and loads beyond the system boundaries	
Raw material supply	Transport	Manufacturing	Transport from gate to site	Assembly	Use	Maintenance	Repair	Replacement	Refurbishment	Operational water use	Operational energy use	De-construction	Transport	Waste processing	Disposal	Reuse	Recycling Potential	
A1	A2	A3	A4	A5	B1	B2	B3	B4	B5	B6	B7	C1	C2	C3	C4	D		
X	X	X	MND	MND	MND	MND	MND	MND	MND	MND	MND	MND	X	X	MND	X		

4. Content declaration

The **BetonWood®** a.s cement-bonded particle boards consists of Portland cement and a mixture of wooden chips. All of the constituents of cement-bonded particleboard are not classified as harmful, nor are listed on the list of Substances of Very High Concern (SVHC).



Product content declaration

All materials/components	Substances	Volume%	CAS number	Environmental class	Health class
Mixture of wood chips	-	63	-	No	No
Portland cement	-	25	-	No	No
Water	-	10	-	No	No
Hydration additives	-	2	-	No	No

5. Environmental performance

Environmental indicators shown below are calculated according to ISO 14025 and EN 15804+A2:2019. Results per declared unit - 1 m³ of cement-bonded particleboard are presented.

5.1. Use of resources

Following table represents Life Cycle Inventory Analysis indicator results.

Resource use. Summarization of modules A1 – A3, C1-C4 and D.

Resource consumption	Unit	BetonWood® standard
Crude oil	MJ	1143
Hard coal	MJ	914
Lignite	MJ	1344
Natural gas	MJ	696
Soil	kg	138
Clay	kg	91
Gravel	kg	90
Inert rock	kg	1676
Limestone (calcium carbonate)	kg	1253
Natural aggregate	kg	129

5.2. Potential environmental impacts

Environmental impacts per declared unit for each module are reported in the following tables.

PERE	Use of renewable primary energy excluding resources used as raw materials
PERM	Use of renewable primary energy resources used as raw materials
PERT	Total use of renewable primary energy
PENRE	Use of non-renewable primary energy excluding resources used as raw materials
PENRM	Use of nonrenewable primary energy resources used as raw materials
PENRT	Total use of non-renewable primary energy



Environmental impact: 1m³ of cement bonded particle board

Parameter	Unit	A1	A2	A3	C1	C2	C3	C4	D
Climate change - total	kg CO ₂ eq.	-1.92E+01	1.08E+01	9.92E-01	8.40E-01	1.05E+01	0.00E+00	1.89E+01	0.00E+00
Climate change - fossil	kg CO ₂ eq.	8.01E+02	1.07E+01	-5.59E+00	8.71E-01	1.04E+01	0.00E+00	2.05E+01	0.00E+00
Climate change - biogenic	kg CO ₂ eq.	-8.21E+02	-1.81E-02	6.59E+00	-3.83E-02	-1.76E-02	0.00E+00	-1.62E+00	0.00E+00
Climate change - land use and land use change	kg CO ₂ eq.	3.82E-01	8.73E-02	-1.13E-02	6.77E-03	8.48E-02	0.00E+00	5.90E-02	0.00E+00
Ozone Depletion	kg CFC11 eq.	8.31E-06	1.98E-15	8.63E-13	1.53E-16	1.92E-15	0.00E+00	7.67E-14	0.00E+00
Acidification	mol H ⁺ eq.	1.32E+00	6.27E-02	2.47E-02	4.27E-03	6.04E-02	0.00E+00	1.47E-01	0.00E+00
Eutrophication aquatic freshwater	kg P eq.	1.90E-02	3.28E-05	6.76E-05	2.55E-06	3.19E-05	0.00E+00	3.53E-05	0.00E+00
Eutrophication aquatic marine	kg N eq.	3.50E-01	3.02E-02	2.33E-02	1.98E-03	2.91E-02	0.00E+00	3.78E-02	0.00E+00
Eutrophication terrestrial	mol N eq.	3.81E+00	3.35E-01	2.51E-01	2.19E-02	3.22E-01	0.00E+00	4.16E-01	0.00E+00
Photochemical ozone formation	kg NMVOC eq.	1.31E+00	5.84E-02	6.73E-02	5.54E-03	5.63E-02	0.00E+00	1.15E-01	0.00E+00
Depletion of abiotic resources - minerals and metals	kg Sb eq.	4.42E-04	8.72E-07	-1.94E-04	6.76E-08	8.47E-07	0.00E+00	1.85E-06	0.00E+00
Depletion of abiotic resources - fossil fuels	MJ, net calorific value	4.34E+03	1.44E+02	-7.12E+01	1.12E+01	1.40E+02	0.00E+00	2.69E+02	0.00E+00
Water use	m ³ world eq. deprived	3.68E+03	1.05E-01	1.98E+00	8.15E-03	1.02E-01	0.00E+00	2.14E+00	0.00E+00
Particulate matter emissions	Disease incidence	2.22E-05	2.30E-07	-4.29E-07	4.81E-08	2.28E-07	0.00E+00	1.82E-06	0.00E+00
Ionizing radiation, human health	kBq U235 eq.	2.72E+01	3.93E-02	-1.98E-02	3.05E-03	3.81E-02	0.00E+00	3.03E-01	0.00E+00
Ecotoxicity (freshwater)	CTUe	1.45E+04	1.08E+02	-3.35E+01	8.35E+00	1.05E+02	0.00E+00	1.53E+02	0.00E+00
Human toxicity, cancer effects	CTUh	3.90E-07	2.23E-09	-1.41E-09	1.73E-10	2.16E-09	0.00E+00	2.27E-08	0.00E+00
Human toxicity, noncancer effects	CTUh	7.59E-06	1.20E-07	1.48E-06	1.02E-08	1.17E-07	0.00E+00	2.51E-06	0.00E+00
Land use related impacts/soil quality	Pt	4.71E+04	5.05E+01	-9.91E+00	3.92E+00	4.90E+01	0.00E+00	5.85E+01	0.00E+00

Resource use, waste and outputs flows: 1m³ of cement bonded particle board

Parameter	Unit	A1	A2	A3	C1	C2	C3	C4	D
PERE	MJ	1.03E+04	8.32E+00	-1.48E+01	6.45E-01	8.08E+00	0.00E+00	3.53E+01	0.00E+00
PERM	MJ	0.00E+00	0.00E+00	0.00E+00	0.00E+00	0.00E+00	0.00E+00	0.00E+00	0.00E+00
PERT	MJ	1.03E+04	8.32E+00	-1.48E+01	6.45E-01	8.08E+00	0.00E+00	3.53E+01	0.00E+00
PENRE	MJ	4.34E+03	1.44E+02	-7.13E+01	1.12E+01	1.40E+02	0.00E+00	2.69E+02	0.00E+00



Beton Wood®

Parameter	Unit	A1	A2	A3	C1	C2	C3	C4	D
PENRM	MJ	0.00E+00	0.00E+00	0.00E+00	0.00E+00	0.00E+00	0.00E+00	0.00E+00	0.00E+00
PENRT	MJ	4.34E+03	1.44E+02	-7.13E+01	1.12E+01	1.40E+02	0.00E+00	2.69E+02	0.00E+00
Use of secondary material	kg	0.00E+00	0.00E+00	0.00E+00	0.00E+00	0.00E+00	0.00E+00	0.00E+00	0.00E+00
Use of renewable secondary fuels	MJ	0.00E+00	0.00E+00	0.00E+00	0.00E+00	0.00E+00	0.00E+00	0.00E+00	0.00E+00
Use of non-renewable secondary fuels	MJ	0.00E+00	0.00E+00	0.00E+00	0.00E+00	0.00E+00	0.00E+00	0.00E+00	0.00E+00
Water	m ³	8.65E+01	9.69E-03	6.28E-03	7.52E-04	9.41E-03	0.00E+00	6.76E-02	0.00E+00
Hazardous waste disposed	kg	9.49E-06	6.68E-06	-1.96E-07	5.18E-07	6.49E-06	0.00E+00	4.10E-06	0.00E+00
Non hazardous waste disposed	kg	5.50E+00	2.29E-02	7.47E+00	1.78E-03	2.22E-02	0.00E+00	1.35E+03	0.00E+00
Radioactive waste disposed	kg	2.52E-01	2.66E-04	-2.47E-04	2.06E-05	2.59E-04	0.00E+00	3.01E-03	0.00E+00
Components for reuse	kg	0.00E+00	0.00E+00	0.00E+00	0.00E+00	0.00E+00	0.00E+00	0.00E+00	0.00E+00
Material for recycling	kg	0.00E+00	0.00E+00	0.00E+00	0.00E+00	0.00E+00	0.00E+00	0.00E+00	0.00E+00
Materials for energy recovery	kg	0.00E+00	0.00E+00	0.00E+00	0.00E+00	0.00E+00	0.00E+00	0.00E+00	0.00E+00
Exported energy electrical	MJ	0.00E+00	0.00E+00	0.00E+00	0.00E+00	0.00E+00	0.00E+00	0.00E+00	0.00E+00
Exported energy thermal	MJ	0.00E+00	0.00E+00	0.00E+00	0.00E+00	0.00E+00	0.00E+00	0.00E+00	0.00E+00

5.3. Release of dangerous substances during the use stage

No health and environmental impacts during use is observed.

6. Additional information

BetonWood srl is constantly attentive to the quality of the products.

The production of **BetonWood®** cementitious particle panels is certified according to the new ISO 9001 standard and is further controlled by authorized and notified bodies.

The company exports its products throughout Europe.

Our **BetonWood®** cement bonded particle board is certified according to European harmonized standards.

The certifications obtained EN ISO 9001 and the commitment of all the company staff offer customers the guarantee of a high quality standard of **BetonWood®** brand products.

Positive attitude to the environment of **BetonWood®**, a.s. is also declared by the certificate of PEFC obtained according to TD CFCS 2002:2013, ensuring that all wood matter used in **BetonWood®** originated from verified resources.

For the installation of **BetonWood®** cement bonded particle products, it is advisable to check the procedures in the Download section on our website www.cementolegno.com.

After the end of life, it is possible to deposit particle boards as common non-hazardous waste.



Cement bonded particle board's characteristics

Density

In accordance with the requirements of EN634-2, article 2, the density of the panels must be greater than 1000 kg/m³. According to the results obtained from tests at a temperature of 20°C, an ambient relative humidity of 50 - 60% and a residual humidity present in the panel equal to 9%, the **BetonWood®** density is $\delta = 1350 \pm 75 \text{ kg/m}^3$. For static calculations - for safety reasons - it is recommended to increase or decrease the maximum value of 20%.

Moisture content in transport

Similarly to wood in natural conditions, **BetonWood®** panels absorb a balanced moisture content depending on the temperature and atmospheric humidity. The moisture content in accordance with the specifications dictated by the MSZ EN634-2 standard is $\mu = 9 \pm 3\%$ achievable in balanced hygroscopic conditions at a temperature of 20°C and a relative humidity of 50 - 60%.

Moisture content depending on the humidity in the air

Figure 1

Average balance of the moisture content of cement bonded particle boards as a function of air humidity, t=20°C

- at a temperature of 20°C and a relative humidity of 35%, the moisture content is about 7%;
- at a temperature of 20°C and a relative humidity of 60%, the moisture content is about 12%;
- at a temperature of 20°C and a relative humidity of 90%, the moisture content is about 19%;

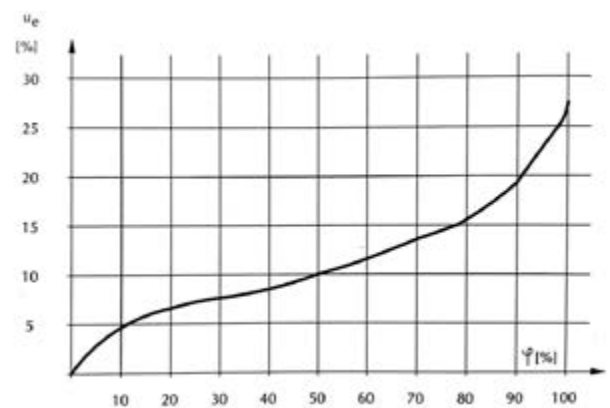

Absorption of water and steam

It is known that humidity plays a significant role in the deterioration process of the wooden materials contained in the panel. Therefore it is very important to determine the rules of water absorption and transmission as accurately as possible.

Absorption of water vapor in the atmosphere with high humidity and high temperatures (tropical climate):

t=40°C
φ=100%

Figure 2

Water vapor absorption of **BetonWood®** in dry condition (t=40°C; φ=100%)

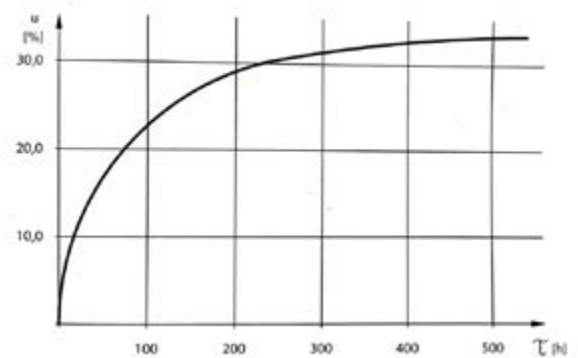



Beton Wood®

Figure 2 shows the average temporary moisture content in **BetonWood®** panels in a dry state as a function of time.

The state of temporary absorption of the cement bonded particle boards shows a deviation. This deviation is due to the heterogeneous and partially organic composition of the panel as well as the difference in density. Within the individual samples, the elements with the highest and lowest density show, respectively, levels of lower and higher absorption and lower and higher values of humidity that the panel is able to absorb have been obtained.

Absorption of water vapor in atmospheric spaces:

t=20 ± 2°C
φ=45 ± 5%

Figure 3

Absorption of the **BetonWood®** panel saturated by exposure to rain, and subsequently dried in atmospheric space (t=20 ± 2°C; φ=45 ± 5%)

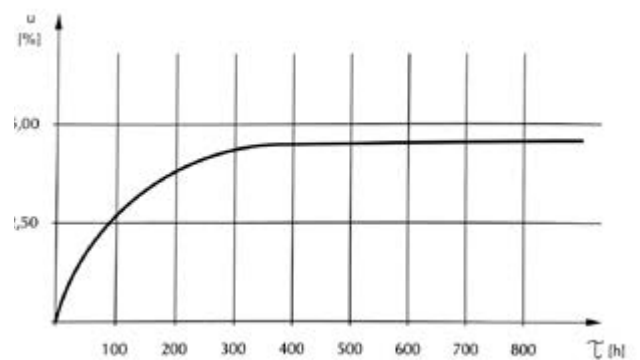

Figures 3 and 4 show the average temporary moisture content in cement bonded particle boards wet to saturation by exposure to rain and steam and subsequently dried to a state of absolute dryness, as a function of time. It can be seen that the maximum water absorption of the pre-treated panel has changed. The balance of moisture content given by the atmosphere should be approximately 7%. The figures show us that not even the pretreated panels reach this value although the available absorption time seems to be sufficient.

Figure 4

Absorption of the vapor-saturated **BetonWood®**, and subsequently dried in atmospheric space (t=20 ± 2°C; φ=45 ± 5%)

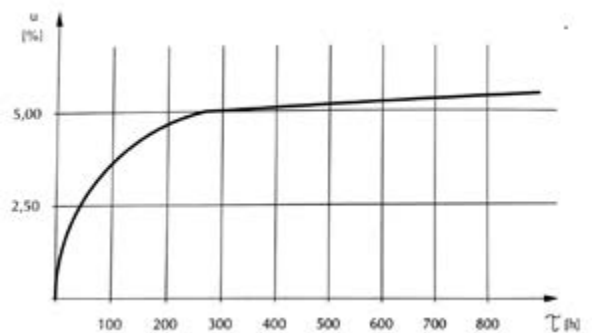

Water absorption in the rain

Water absorption with temperature 14 ± 0,5°C and water pressure equal to 2 bar:

t=14 ± 0,5°C
p=2 bars

Figure 5

Absorption of the **BetonWood®** panel saturated by exposure to rain (t=14 ± 0,5°C; p=2 bars)

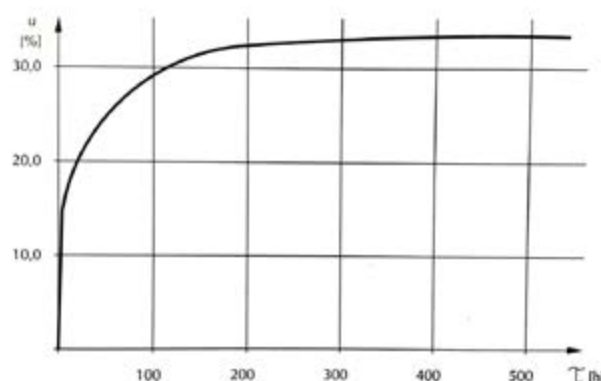



Beton Wood®

Figure 5 shows the average temporary moisture content of the perfectly dry panel when exposed to the rain, as a function of the weather. The moisture resistance of **BetonWood®** panels is proven to be excellent.

Desorption of BetonWood® panels

Desorption in atmospheric spaces

$t=20 \pm 2^\circ\text{C}$
 $\varphi=50 \pm 5\%$

Figure 6

Desorption of **BetonWood®** panels saturated with water vapor absorbed in the atmospheric environment ($t=20 \pm 2^\circ\text{C}$; $\varphi=50 \pm 5\%$)

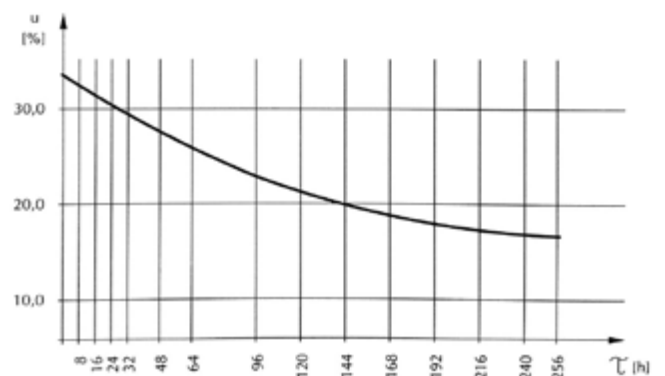
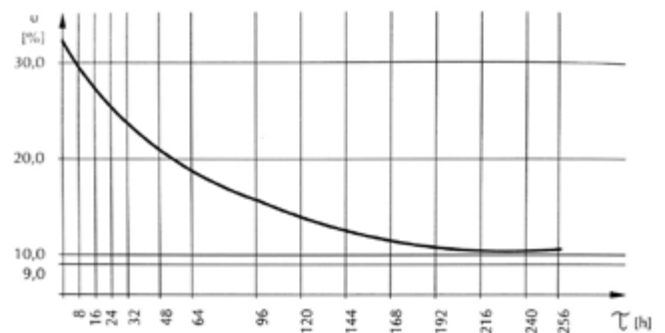

Figure 7

Desorption of **BetonWood®** panels saturated with water vapor absorbed in an atmospheric environment ($t=20 \pm 2^\circ\text{C}$; $\varphi=50 \pm 5\%$)

Figures 6 and 7 show the average temporary moisture content in cement bonded particle boards wet up to saturation by the absorption of water vapor and exposure to rain, respectively, as a function of time.

Desorption of the panel in a balanced state in atmospheric spaces up to a state of absolute dryness:

$t=102^\circ\text{C}$
 $\varphi=0\%$

Figure 8

Desorption of **BetonWood®** panels saturated by the absorption of water vapor in the atmospheric environment to a state of absolute dryness ($t=102^\circ\text{C}$; $\varphi=0\%$)

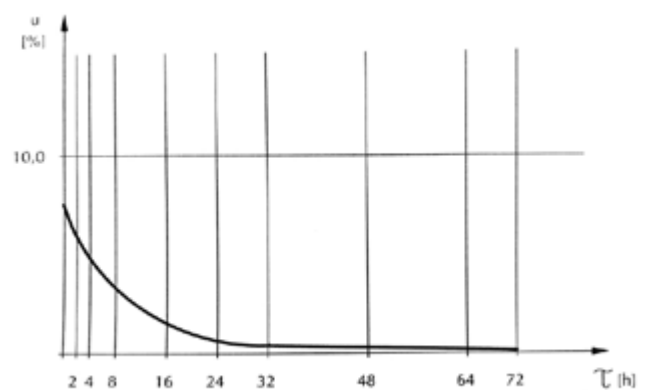
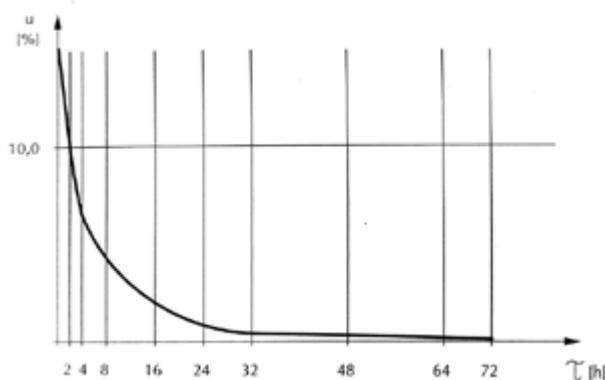



Figure 9

Desorption of **BetonWood**[®] panels saturated by exposure in the rain in an atmospheric environment to a state of absolute dryness ($t=102^{\circ}\text{C}$; $\varphi=0\%$)

Figures 8 and 9 show the average temporary moisture content in cement bonded particle boards wet to saturation through the absorption of water vapor and exposure to rain, respectively, as a function of time.



Conclusion

It can be said that the maximum water absorption of cement bonded particle boards is not greater than 35% even for conditions of permanent humidity or immersion. It is independent of the method of increasing humidity used. The waterproofing pre-treatment of the panels significantly affects the absorption characteristics.

Water absorption of the panels by soaking

Figure 10 shows the average temporary moisture content of the perfectly dry **BetonWood**[®] panel as a function of time. The resulting curve runs logarithmically, precisely indicating the diffusion rules.

It can be said that initially the absorption of water increases drastically and reaches a μ_{max} value after about 50 hours of soaking. There was no significant change in moisture content after this soak time.

La media del valore μ_{max} è 27%.

Figure 10

Water absorption of the **BetonWood**[®] panel by soaking.

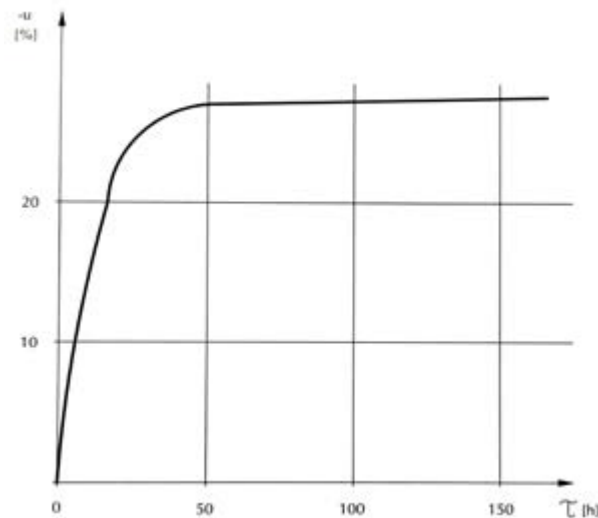



Resistance to deformation

The two layers of the cement bonded particle boards are generally subjected to an asymmetrical climatic load. A test was carried out under the following extreme conditions: the upper part of the specimen placed freely in a water bath was brought into contact with the air at a temperature $t=20 \pm 2^\circ\text{C}$ and a relative humidity $\phi=65 \pm 5\%$. Figure 11 shows the arrangement of the measuring points as a result of deformation, as a function of time.

Figure 11

The measurement points arranged due to the asymmetrical climatic load reported as a function of time

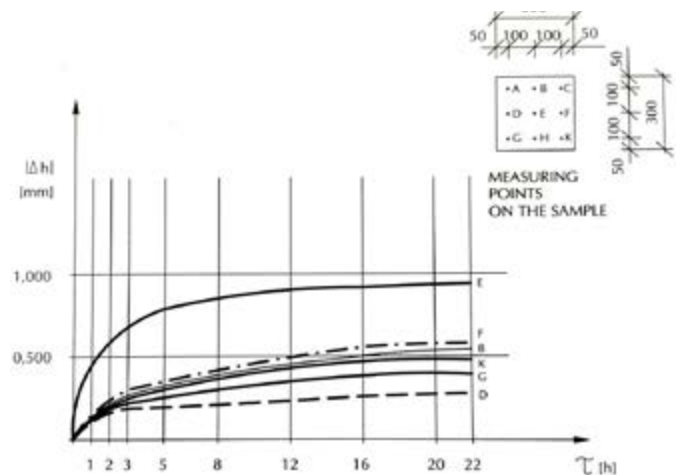
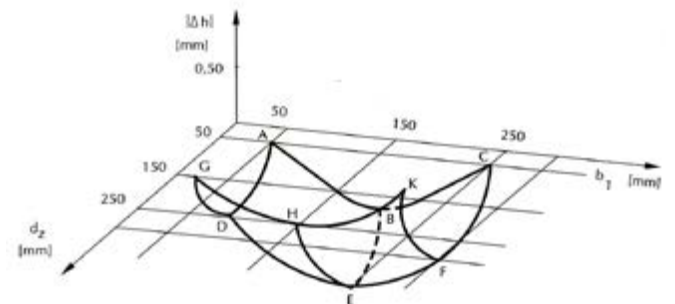

Figure 12

Axonometric drawing of the highest deformation

The most drastic deformation can be observed in the first 3 days. The highest deformation can be noticed on the 22nd day. In subsequent observations the deformation is insignificant.



Thermodynamic characteristics of cement bonded particle board

Parameters	Unit	Value
Density	kg/m ³	1350 ± 100
Fire reaction according to EN 13501-1	-	A2-fl-s1
Thermal conductivity coefficient (λ)	W/(m•K)	0,26
Specific heat (c)	J/(kg•K)	1880
Coefficient of linear thermal expansion (α)	K ⁻¹	1,0 × 10 ⁻⁵
Steam penetration coefficient (Δ)	kg/m s Pa	0,83 × 10 ⁻¹¹

Table 1 Construction features of the cement bonded particle boards



Parameters	Unit	Value
Thermal conductivity coefficient (λ)	W/(m•K)	0,26
Specific heat (c)	J/(kg•K)	1880
Coefficient of resistance to vapor penetration (μ)	-	22,6
Steam penetration coefficient (D)	-	0,0039
Air permeability	l/min. m² Mpa	0,133

Table 2 Construction characteristics of cement bonded particle boards according to DIN 4108

Thickness mm	Thermal resistance m² K/W
8	0,0308
10	0,0385
12	0,0461
14	0,0538
16	0,0615
18	0,0692
20	0,0769
24	0,0923
28	0,1077
40	0,1538

Thickness mm	Heat transmission W/m² K
8	3,666
10	3,565
12	3,471
14	3,381
16	3,295
18	3,213
20	3,136
24	2,991
28	2,860
40	2,527

Table 3 Thermal resistance values of the panels as the thickness varies

Table 4 Heat transmission values of the panels as the thickness varies

Fire resistance class

BetonWood® panels fall into the fire resistance category **A2-fl-s1**. Below are the previews of the LAPI certification which can be freely consulted on our website at:

<http://www.betonwood.com/pdf/certificazione-al-fuoco-A2fl-s1.pdf>





Betonwood®

Cement bonded particle board with high compression resistance

The **BetonWood®** cement bonded particle board is made of debarked pine wood fibers from forests controlled by FSC® reforestation cycles and pressed with water and hydraulic binder (Portland cement) with high cold compression ratios. It is a multifunctional building material suitable for use in: roofs, attics, intermediate floors, ceilings, walls and traditional and raised floors.

BetonWood® has a high density (1350 Kg/m³) and a high compressive strength (9000 KPa) and is therefore suitable for use in dry screeds, thermal insulating composite systems (see our **Betontherm** systems), radiant heating systems (see our **Betonradiant** systems) and in all public places where there is a need for a hard, resistant material, certified to fire in class A2.

Through coupling with insulating materials and surface processing, we have made it suitable for multiple uses such as radiant floors and armored thermal insulating systems.

It is guaranteed by constant checks carried out by external bodies which certify its high quality and, thanks to its high percentage of recycled material (35%), it fully complies with the **Minimum Environmental Criteria** and is **CAM** certified.

density 1350kg/m³



Advantages

- high compression strength;
- resistant to climate change and frost;
- resistant to the external environment;
- insects and fungi are unable to attack or damage it;
- thanks to its physical and mechanical characteristics, the product is considered one of the best materials for light weight constructions;
- incombustible (A2 according to the Standard DIN 4102);
- formaldehyde and asbestos free.;
- free from recycled inks;
- weather resistant;
- workable with wooden tools;
- high loading capacity;
- creates a healthy and completely natural internal atmosphere;
- recyclable, ecological, respects the environment;
- construction material tested and authorized according to the European standards in force.

Uses in construction

- √ BetonRadiant radiant floors and pre-reinforced floors;
- √ roofs with high thermal displacement;
- √ fire resistant ceilings, suspended ceilings and walls;
- √ fireproof walls;
- √ self-supporting and sound-absorbing walls;
- √ structure for floors and raised floors;
- √ load support for floor and walls;
- √ office partitions;
- √ fixtures;
- √ external and internal coatings;
- √ platforms for counters, platforms and slides;
- √ exhibition stands and prefabricated boxes;
- √ road and railway noise barriers;
- √ disposable formwork;
- √ reinforced insulating composite system Betontherm;
- √ vandal-proof protective coatings;
- and much more..

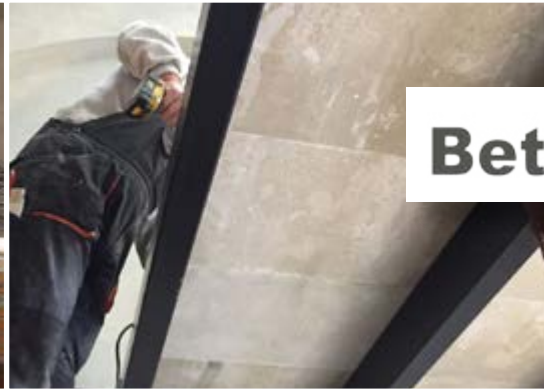

Available sizes

sharp edges

Thickness mm	Size mm	m ³ /panel	kg/m ²	panels/pallet	m ² /pallet	kg/pallet
10	3200 x 1250	0,040	13,50	60	240,00	approx. 3.000
12	3200 x 1250	0,048	16,20	50	200,00	approx. 3.000
14	3200 x 1250	0,056	18,90	40	160,00	approx. 3.200
16	3200 x 1250	0,064	21,60	35	140,00	approx. 3.200
18	3200 x 1250	0,072	24,30	30	120,00	approx. 3.100
20	3200 x 1250	0,080	27,00	30	120,00	approx. 3.400
22	3200 x 1250	0,088	29,70	25	100,00	approx. 3.200
24	3200 x 1250	0,096	32,40	25	100,00	approx. 3.400
28	3200 x 1250	0,112	37,80	20	80,00	approx. 3.200
32	3200 x 1250	0,128	43,20	20	80,00	approx. 3.600
40	3200 x 1250	0,160	54,00	15	60,00	approx. 3.400

Thickness mm	Size mm	m ³ /panel	kg/m ²	panels/pallet	m ² /pallet	kg/pallet
8	2800 x 1250	0,028	10,80	70	245,00	approx. 2.800
10	2800 x 1250	0,035	13,50	60	210,00	approx. 3.000
12	2800 x 1250	0,042	16,20	50	175,00	approx. 3.000
14	2800 x 1250	0,049	18,90	40	140,00	approx. 2.800
16	2800 x 1250	0,056	21,60	35	122,50	approx. 2.800
18	2800 x 1250	0,063	24,30	30	105,00	approx. 2.700
20	2800 x 1250	0,070	27,00	30	105,00	approx. 3.000
22	2800 x 1250	0,077	29,70	25	87,50	approx. 2.800
24	2800 x 1250	0,084	32,40	25	87,50	approx. 3.000
28	2800 x 1250	0,098	37,80	20	70,00	approx. 2.800
32	2800 x 1250	0,112	43,20	20	70,00	approx. 3.200
36	2800 x 1250	0,140	54,00	15	52,50	approx. 2.700



Structural characteristics - Load capacity

Thickness mm	Uniformly distributed load kN/m ²							
	1,00	1,50	2,00	2,50	3,00	4,00	5,00	6,00
	Interaxle spacing cm							
8	36	30	26	24	22	19	17	16
10	45	37	33	29	27	24	21	20
12	55	46	40	36	33	29	26	24
14	63	52	46	41	38	33	30	27
16	72	60	53	48	44	38	34	31
18	80	67	59	53	49	43	39	35
20	88	74	65	59	54	48	43	39
22	97	81	72	64	59	52	47	42
24	103	88	78	70	65	57	51	47
28	118	101	89	81	75	66	59	51
32	142	119	104	94	87	76	69	62
36	160	134	118	106	98	86	78	70
40	178	148	130	117	108	95	85	79

Acoustic performance

Thickness mm	Soundproofing power dB					
	100	200	400	800	1600	3150
	Frequency Hz					
8	12,1	16,9	21,9	27,2	32,5	37,8
10	13,7	18,6	23,7	29,0	34,4	39,7
12	14,6	19,6	24,7	30,0	35,5	40,8
14	15,8	20,8	26,0	31,4	36,8	42,2
16	16,9	21,9	27,2	32,5	38,0	43,3
18	17,5	22,6	27,8	33,2	38,7	44,0
20	18,3	23,5	28,7	34,1	39,6	45,0
22	19,0	23,1	29,3	34,8	40,2	45,9
24	19,6	24,7	30,0	35,5	40,9	46,4
28	20,8	26,0	31,4	36,8	42,3	47,7
32	21,9	26,8	32,5	37,7	43,4	48,5
36	22,4	27,6	33,2	38,7	44,3	49,6
40	23,5	28,7	34,1	39,6	45,1	50,6

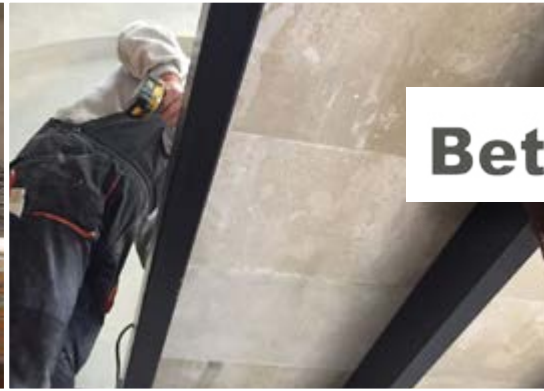

Technical characteristics

Characteristics	Value
Density kg/m ³	1350
Reaction to fire according to the standard EN 13501-1	A2-fl-s1
Coefficient of thermal conductivity λ_D W/(m·K)	0,26
Specific heat J/(kg·K)	1880
Resistance to vapor diffusion μ	22,6
Coefficient of linear thermal expansion α	0,00001
Thick swelling after 24h of permanence in water	1,5%
Change in length and width due to humidity	max 0,3% with temp>20°C and humid. 25% a 90%
Air permeability l/min.m ² MPa	0,133
Surface PH value	11
Flexural strength σ (N/mm ²)	min.9 (9.000kPa)
Transverse tensile strength N (N/mm ²)	min.0,5
Shear resistance τ (N/mm ²)	0,5
Elasticity module E (N/mm ²)	1stc.: 4500 2stc.:4000
Resistance to distributed load kPa	9000
Concentrated load resistance kN	9

Tolerance

Thickness mm	Weight kg/m ²	Thickness tolerance Class I
8	11.2	± 0,7
10	14.0	± 0,7
12	16.8	± 1,0
14	19.6	± 1,0
16	22.4	± 1,2
18	25.2	± 1,2
20	28.0	± 1,5
24	33.6	± 1,5
28	39.2	± 1,5
40	56.0	± 1,5



Beton Wood®

Betonwood® N

Cement bonded particle board with handy format

The **BetonWood®N** cement bonded particle board panel is made, just like **BetonWood®**, in debarked pine wood fibers from forests controlled by FSC® reforestation cycles and pressed with water and hydraulic binder (Portland cement) with high cold compression ratios.

It is a multifunctional building material suitable for use in: roofs, attics, intermediate floors, ceilings, walls and traditional and raised floors.

BetonWood® has a high density (1350 Kg/m³) and a high compressive strength (9000 KPa) and is therefore suitable for use in dry screeds, thermal insulating composite systems (see our **Betontherm** systems), radiant heating systems (see our **Betonradiant** systems) and in all public places where there is a need for a hard, resistant material, certified to fire in class A2.

Through coupling with insulating materials and surface processing, we have made it suitable for multiple uses such as radiant floors and armored thermal insulating systems.

It is guaranteed by constant checks carried out by external bodies which certify its high quality and, thanks to its high percentage of recycled material (35%), it fully complies with the **Minimum Environmental Criteria** and is **CAM** certified.

density 1350kg/m³



Advantages

- high compression strength;
- resistant to climate change and frost;
- resistant to the external environment;
- insects and fungi are unable to attack or damage it;
- thanks to its physical and mechanical characteristics, the product is considered one of the best materials for light weight constructions;
- incombustible (A2 according to the Standard DIN 4102);
- formaldehyde and asbestos free.;
- free from recycled inks;
- weather resistant;
- workable with wooden tools;
- high loading capacity;
- creates a healthy and completely natural internal atmosphere;
- recyclable, ecological, respects the environment;
- construction material tested and authorized according to the European standards in force.

Uses in construction

- √ BetonRadiant radiant floors and pre-reinforced floors;
- √ roofs with high thermal displacement;
- √ fire resistant ceilings, suspended ceilings and walls;
- √ fireproof walls;
- √ self-supporting and sound-absorbing walls;
- √ structure for floors and raised floors;
- √ load support for floor and walls;
- √ office partitions;
- √ fixtures;
- √ external and internal coatings;
- √ platforms for counters, platforms and slides;
- √ exhibition stands and prefabricated boxes;
- √ road and railway noise barriers;
- √ disposable formwork;
- √ reinforced insulating composite system Betontherm;
- √ vandal-proof protective coatings;
- and much more..



Available sizes

sharp edges

Standard sized panels:

Thickness mm	Size mm	Finishing	m ³ /panel	kg/m ²	panels/pallet	m ² /pallet	kg/pallet
22	1220 x 520	semi-sanded	0,012	18,71	50	35,53	approx. 1000

Special sized panels, on request:

Thickness mm	Size mm	Finishing	m ³ /panel	kg/m ²	panels/pallet	m ² /pallet	kg/pallet
10	1250 x 600	standard	0,007	10,12	50	50,00	approx. 750
10	1250 x 800	standard	0,010	13,50	47	47,00	approx. 635
16	1250 x 465	standard	0,009	12,53	60	34,87	approx. 755
22	1220 x 515	semi-sanded	0,013	18,66	50	35,18	approx. 1000

Finishes: by standard finish we mean gray in appearance, very similar to concrete; the semi-sanded panel, on the one hand will be similar to concrete (therefore with a standard finish) and on the other more brown, like wood.

Structural characteristics - Load capacity

Thickness mm	Uniformly distributed load kN/m ²							
	1,00	1,50	2,00	2,50	3,00	4,00	5,00	6,00
10	45	37	33	29	27	24	21	20
16	72	60	53	48	44	38	34	31
22	97	81	72	64	59	52	47	42

Acoustic performance

Thickness mm	Soundproofing power dB					
	100	200	400	800	1600	3150
10	13,7	18,6	23,7	29,0	34,4	39,7
16	16,9	21,9	27,2	32,5	38,0	43,3
22	19,0	23,1	29,3	34,8	40,2	45,9



Technical characteristics

Characteristics	Value
Density kg/m ³	1350
Reaction to fire according to the standard EN 13501-1	A2-fl-s1
Coefficient of thermal conductivity λ_D W/(m·K)	0,26
Specific heat J/(kg·K)	1880
Resistance to vapor diffusion μ	22,6
Coefficient of linear thermal expansion α	0,00001
Thick swelling after 24h of permanence in water	1,5%
Change in length and width due to humidity	max 0,3% with temp>20°C and humid. 25% a 90%
Air permeability l/min.m ² MPa	0,133
Surface PH value	11
Flexural strength σ (N/mm ²)	min.9 (9.000kPa)
Transverse tensile strength N (N/mm ²)	min.0,5
Shear resistance τ (N/mm ²)	0,5
Elasticity module E (N/mm ²)	1stc.: 4500 2stc.:4000
Resistance to distributed load kPa	9000
Concentrated load resistance kN	9



Beton Wood®

Betonwood® sanded

Cement bonded particle boards with sanded surfaces

density 1350kg/m³



The **BetonWood® sanded** cement bonded particle board is made of debarked pine wood fibers from forests controlled by FSC® reforestation cycles and pressed with water and hydraulic binder (Portland cement) with high cold compression ratios.

This panel, unlike **BetonWood®**, is subjected to a sanding process that changes its appearance. In this way the panel has features that are closer to wood rather than to a cement mixture. The sanding can also be applied to other panels of the **BetonWood®** range.

BetonWood® sanded has a high density (1350 Kg/m³) and a high compressive strength (9000 KPa) and is therefore suitable for use in all public places where there is a need for a hard, resistant material, certified to fire in class A2.

It is guaranteed by constant checks carried out by external bodies which certify its high quality and, thanks to its high percentage of recycled material (35%), it fully complies with the **Minimum Environmental Criteria** and is **CAM** certified.



Advantages

- high compression strength;
- resistant to climate change and frost;
- insects and fungi are unable to attack or damage it;
- one of the best lightweight construction materials;
- incombustible (A2 according to the Standard DIN 4102);
- formaldehyde and asbestos free.;
- free from recycled inks;
- workable with wooden tools;
- high load capacity;
- creates a healthy and completely natural internal atmosphere;
- recyclable, ecological, respects the environment;
- tested and authorized according to the European standards in force.

Uses in construction

- √ interior outfitting;
- √ ceilings and counter-ceilings;
- √ self-supporting and sound-absorbing walls;
- √ structure for floors and raised floors;
- √ office partitions;
- √ fixtures;
- √ external and internal cladding;
- √ platforms for counters, platforms and slides;
- √ exhibition stands and prefabricated boxes;
- √ counter-walls for gyms;
- √ allestimenti per negozi;
- and much more..

Available sizes

sharp edges

Thickness mm	Size mm	Finishing	m ³ /panel	kg/m ²	panels/pallet	m ² /pallet	kg/pallet
20	1220 x 520	sanded	0,012	18,71	56	35,53	approx. 1000

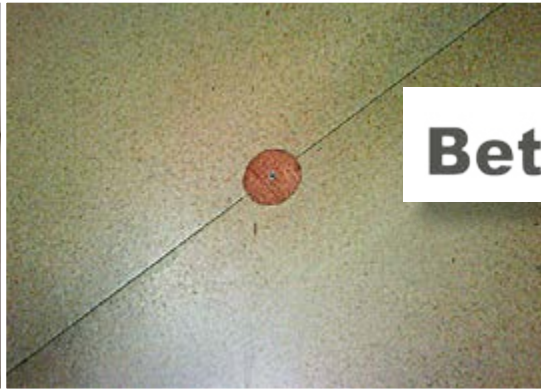

Structural characteristics - Load capacity

Thickness mm	Uniformly distributed load kN/m ²							
	1,00	1,50	2,00	2,50	3,00	4,00	5,00	6,00
	Interaxle spacing cm							
20	88	74	65	59	54	48	43	39

Acoustic performance

Thickness mm	Soundproofing power dB					
	100	200	400	800	1600	3150
	Frequency Hz					
20	18,3	23,5	28,7	34,1	39,6	45,0

Technical characteristics

Characteristics	Value
Density kg/m ³	1350
Reaction to fire according to the standard EN 13501-1	A2-fl-s1
Coefficient of thermal conductivity λ_D W/(m·K)	0,26
Specific heat J/(kg·K)	1880
Resistance to vapor diffusion μ	22,6
Coefficient of linear thermal expansion α	0,00001
Thick swelling after 24h of permanence in water	1,5%
Change in length and width due to humidity	max 0,3% with temp>20°C and humid. 25% a 90%
Air permeability l/min.m ² MPa	0,133
Surface PH value	11
Flexural strength σ (N/mm ²)	min.9 (9.000kPa)
Transverse tensile strength N (N/mm ²)	min.0,5
Shear resistance τ (N/mm ²)	0,5
Elasticity module E (N/mm ²)	1stc.: 4500 2stc.:4000
Resistance to distributed load kPa	9000
Concentrated load resistance kN	9



Beton Wood®

Betonwood® tongue&groove

Cement bonded particle boards with tongue&groove edges

density 1350kg/m³

The **BetonWood®tongue&groove** cement bonded particle board is made, just like **BetonWood®**, in debarked pine wood fibers from forests controlled by FSC® reforestation cycles and pressed with water and hydraulic binder (Portland cement) with high cold compression ratios .

It is a multifunctional building material, and, thanks to the special structure of its edges, it is suitable for use in intermediate floors, traditional floors and raised floors on supports with adjustable height.

Also suitable for solutions with corrugated sheet metal and cork; or placed on loose insulating material straightened as **CorkGranules**.

BetonWood® has a high density (1350 Kg/m³) and a high compressive strength (9000 KPa) and is therefore suitable for use in dry screeds and in all public places where there is a need for a hard, resistant material, certified to fire in class A2.

It is guaranteed by constant checks carried out by external bodies which certify its high quality and, thanks to its high percentage of recycled material (35%), it fully complies with the **Minimum Environmental Criteria** and is **CAM** certified.



Advantages

- high compression strength;
- resistant to climate change and frost;
- insects and fungi are unable to attack or damage it;
- one of the best lightweight construction materials;
- incombustible (A2 according to the Standard DIN 4102);
- formaldehyde and asbestos free.;
- free from recycled inks;
- weather resistant;
- workable with wooden tools;
- high load capacity;
- recyclable, ecological, respects the environment;
- tested and authorized according to the European standards in force.

Uses in construction

- √ floating dry screeds;
 - √ load support for floors;
 - √ structure for floors and raised floors;
 - √ load support for floor and walls;
 - √ floors with impact sound insulation for offices;
 - √ platforms for counters, platforms and slides;
 - √ exhibition stands and prefabricated boxes;
 - √ raised floors on adjustable supports;
 - √ floating floors on cork granules;
 - √ modular systems for prefabricated floors;
 - √ underlay for radiant floors BetonRadiant.
- and much more..

Available sizes

tongue&groove edges

Thickness mm	Size mm	Finishing	m ³ /panel	kg/m ²	panels/pallet	m ² /pallet	kg/pallet
22	1200 x 500	semi-sanded	0,013	17,82	25	15,00	approx. 1000
22	1200 x 500	sanded	0,013	17,82	25	15,00	approx. 410

The semi-sanded panel, on the one hand, will be similar to concrete (therefore with a standard finish) and on the other more brown, like wood.

Structural characteristics - Load capacity

Thickness mm	Uniformly distributed load kN/m ²							
	1,00	1,50	2,00	2,50	3,00	4,00	5,00	6,00
	Interaxle spacing cm							
22	97	81	72	64	59	52	47	42
44	175	148	130	117	108	95	85	79

Acoustic performance

Thickness mm	Soundproofing power dB					
	100	200	400	800	1600	3150
	Frequency Hz					
22	19,0	23,1	29,3	34,8	40,2	45,9
44	23,5	28,7	34,1	39,6	45,1	50,6

Technical characteristics

Characteristics	Value
Density kg/m ³	1350
Reaction to fire according to the standard EN 13501-1	A2-fl-s1
Coefficient of thermal conductivity λ_D W/(m·K)	0,26
Specific heat J/(kg·K)	1880
Resistance to vapor diffusion μ	22,6
Coefficient of linear thermal expansion α	0,00001
Thick swelling after 24h of permanence in water	1,5%
Change in length and width due to humidity	max 0,3% with temp>20°C and humid. 25% a 90%
Air permeability l/min.m ² MPa	0,133
Surface PH value	11
Flexural strength σ (N/mm ²)	min.9 (9.000kPa)
Transverse tensile strength N (N/mm ²)	min.0,5
Shear resistance τ (N/mm ²)	0,5
Elasticity module E (N/mm ²)	1stc.: 4500 2stc.:4000
Resistance to distributed load kPa	9000
Concentrated load resistance kN	9



Special processing

Additional sanding processes and cuts

Type	Thickness mm	Priceo € / m ²
sanding	-	2,60
cut	-	2,60
cut	8 - 12	0,90
cut	14 - 20	1,30
cut	22 - 32	2,10
cut	36 - 40	3,80

N.B.: all panels with a thickness of 22 mm have a semi-polished surface finish (half-sanded)

Customization of thicknesses and sizes

On special agreements, panels with a different thickness than those indicated can be supplied, remaining in the range between 8 and 40 mm.

The panels can also be supplied with customized dimensions for certain quantities to be established directly with the [sales office](#).

The **BetonWood®** cement bonded particle boards are also available in the **Sanded** version, coming from standard panels suitably sanded and calibrated with special machinery, to bring the thickness of the panels to lower dimensional tolerances. These particular insulating panels have the characteristic of being aesthetically pleasing, as the wood contained inside stands out in the upper and lower part, compared to the standard panel, which has the particularity of having a totally concrete appearance. The **BetonWood®** cement bonded particle board insulating panels can be worked on the edges in order to facilitate the joints during the installation phase:

- rabbeted edge with thicknesses less than 14 mm
- tongue&groove edge with thicknesses greater than 18 mm



Beton Wood®

Storage & transport

Packaging of BetonWood® panels

The product is packed on pallets or wooden beams directly in the factory.

A protective layer of lower category chipboard or cement bonded particle board is placed on the top and bottom of each pallet. The pallets of panels are blocked by special plastic straps, and the edges of the cement bonded particle boards under them are protected.

The total weight of a standard pallet is approximately 3200/3500 kg.

The total weight of a **BetonWood®N** pallet, on the other hand, is approximately 1000 kg.

Transport precautions

Pallets are normally delivered by truck or courier.

Given the high mass of the pallets, it is advisable for the recipient to have suitable equipment and mechanical lifting means with maximum capacities of 3500 / 4000kg for unloading the goods.

Further transport or unloading must be regulated and organized by the customer himself / with collection from our warehouses or with delivery by courier.

Deposit of BetonWood® panels

Correct storage is essential for the correct conservation of the material:

- it is advisable to position the panels one on top of the other in order to keep them in a horizontal position, with square section supports and a minimum spacing of 80 cm. Avoid bowing with intermediate supports (see figure).
- the panels must be supported for their total length by wooden beams positioned in at least four points at a uniform distance. The maximum center distance between the wooden supports must be no more than 800 mm.
- when handling the BetonWood® panels individually, it is recommended to take them by cutting, never horizontally, just like a sheet of glass (see figure).
- the pallet must be protected with suitable sheets to avoid the accumulation of dust and avoid contact with moisture from the ground and rain.
- after having partially used the pallet panels, the protective chipboard panel must be restored and a ballast must be positioned on the upper side of the remaining panels to avoid distortion of the upper panels.
- avoid storing the panels by placing them on the edge (see figure).
- avoid direct exposure of the panels to sunlight during storage.

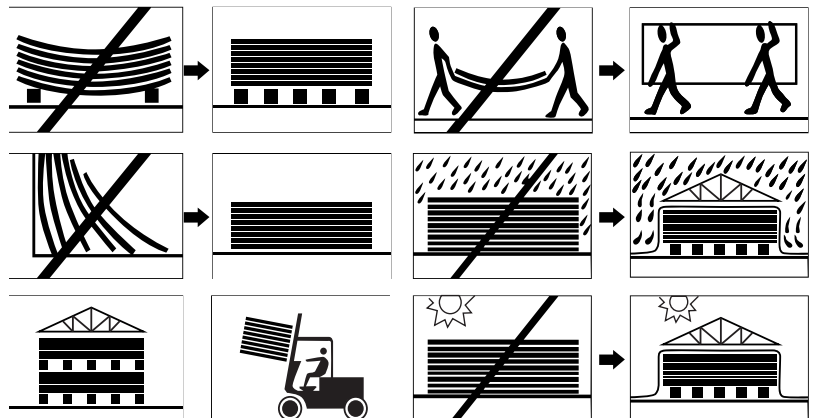



Acoustic insulation

The cement bonded particle board panel by nature and intrinsic characteristics lends itself to excellent noise reduction. Its consistent mass favors the reduction of high frequencies and its heterogeneous composition contributes greatly to increasing sound insulation.

The noise reduction coefficient is 30 dB for a 12 mm thick board with a coincidence frequency of 4200 in the BERGER diagram.

Acoustic insulation as a function of thickness

Thickness mm	Limit frequency Hz	medium sound absorption R (dB)
8	6300	27
10	5000	29
12	4200	30
16	3100	32
18	2800	31
20	2500	32
24	2100	33
28	1800	34

Resistance properties according to European International Standards

Name/Unit	Standard	Value (for every thickness)
Density (kg/m ³)	MSZ EN 323	min. 1000
Flexural strength σ (N /mm ²)	MSZ EN 310	9
Transverse tensile strength (N /mm ²)	MSZ EN 319	0,5
Transverse tensile strength after cyclic test (N /mm ²)	MSZ EN 319 e 321	0,3
Thick swelling after 24 hours (%)	MSZ EN 317	1,5
Thickness swelling after cyclic test (%)	MSZ EN 319 e 321	1,5
Elasticity module E (N /mm ²)	MSZ EN 310	class 1: 4500 class 2:4000



General properties of **resistance**

To limit stress, the specifications given by the MSZ 15025/1989 regulations should be adopted as a guide to the design of building structures. When designing building structures, the following permissible stresses must be taken into account based on the data provided by the "Institut für Bautechnik" in Berlin.

- permitted bending strength for loads perpendicular to the panel surface: **1,8 N/mm²**
- permissible tensile strength flat on the panel: **0,8 N/mm²**
- compressive strength allowed in plane to the panel: **2,5 N/mm²**
- modulus of elasticity in bending for calculation purposes: **2000 N/mm²**

There is approximately a linear correlation between the flexural strength and the modulus of elasticity for **BetonWood®** panels. It is shown in figure 13.

Figure13

Correlation of the flexural strength with the curve of the modulus of elasticity of the **BetonWood®** panels

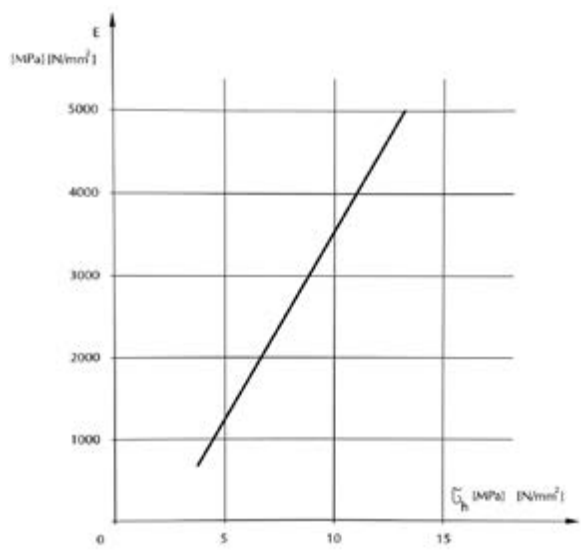

Resistance to deformation of the **BetonWood®** panels

Specimens with uniform cross section but different length were used for testing. Figure 14 shows a varied range of section reductions and the corresponding critical resistance values.

Figure 14

Critical resistance value as a function of the **BetonWood®** panel thickness reduction

In **BetonWood®** panels, deformation occurs on large-format panels and not on small-format ones. The deformation resistance can be determined by a simple accurate calculation.

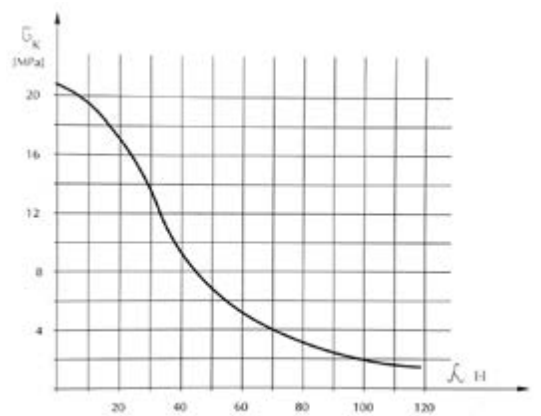

Behavior of panels under the influence of a thermal load

The thermodynamic curve can be obtained by plotting the deformation as a function of temperature. Figure 15 shows the specific strain for individual tempering values and two stress levels.



Beton Wood®

Figure 15

Thermodynamic curves of the **BetonWood®** panels

1. Curve corresponding to 35% of the flexural strength, and to the nominal stress $\bar{\sigma}_1 = 3,79$ MPa
2. Curve corresponding to 70% of the flexural strength, and to the nominal stress $\bar{\sigma}_1 = 7,59$ MPa

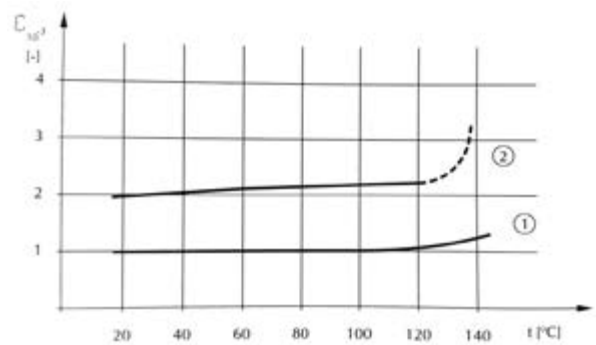

The test indicates that:

- the thermodynamic curve can be considered linear above a temperature of 120°C;
- the straight section corresponding to the highest nominal stress is steeper thanks to the effect of the temperature increase on the non-linear part of the diagram;
- for higher nominal stress, from a temperature of 100°C, an increasing number of samples did not pass the load tests, at a temperature of 140°C all the samples failed under load.
- the highest thermal load limit for **BetonWood®** panels is 120°C

Effect of moisture content on resistance values

The different resistance values of the cement bonded particle boards are interconnected with the humidity content prevailing at a given time. Figure 16 clearly shows this relationship.

— COMPRESSION STRENGTH
 - - - TENSILE STRENGTH
 - - - BENDING STRENGTH
 - - - SHEAR STRENGTH PARALLEL TO PLANE OF BOARD
 — SHEAR STRENGTH PERPENDICULAR TO PLANE OF BOARD
 — IMPACT AND BREAKING STRENGTH

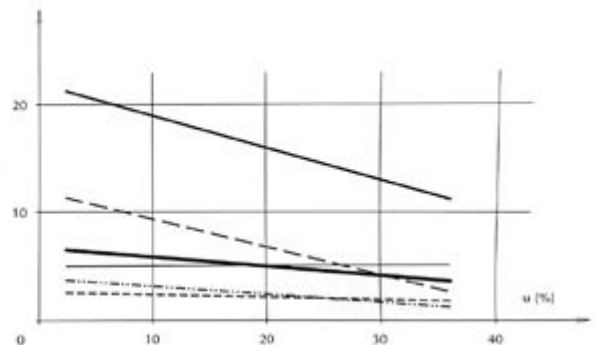

Figure 16

Resistance change as a function of moisture content

It can be said that the compressive strength and flexural strength decrease considerably thanks to the increase in the moisture content. The tensile, shear and break resistance changes slightly under the influence of the moisture content. The impact resistance to breakage, unlike the other properties, slightly improves thanks to the increase in the moisture content.

Viscous flow in BetonWood® panels due to bending stress

For the design of load-bearing structures intended to last the change of individual properties over time plays a significant role. It should be taken into consideration, when designing building structures, that the macromolecular composition of the wood changes some mechanical properties while the physical properties remain unaltered. Figure 17 shows the change in deformation as a function of load factor and time.



BetonWood®

Figure 17

Change of deformation in **BetonWood®** panels as a function of load coefficient and time

Tests have shown that initial elastic deformations are much more favorable for cement bonded particle boards than traditional building boards. This happens thanks to the very high flexural rigidity. The initial elastic deformation of **BetonWood®** building panels is only 1/5 of the value obtained for the panels used in furniture.

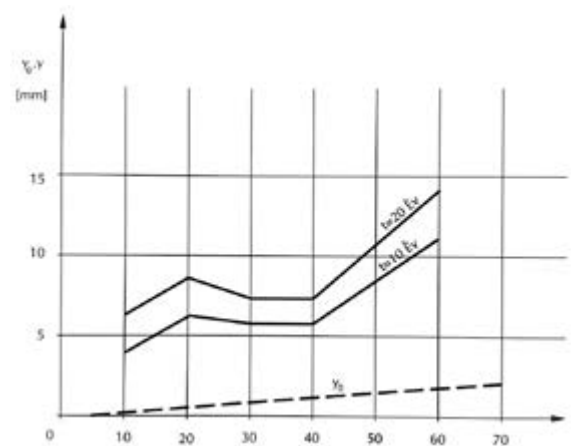

The degree of creep can be clearly characterized by the multiplication factor α , which depends on the loading time and when multiplied by the references y_0 the actual deformation corresponds to the loading time t . Although the α values for cement bonded particle boards are usually 2-4 times greater than those obtained for standard panels, if the loading time exceeds 1 year, the actual deformations will be significantly lower.

The viscous flow of cement bonded particle boards consists of 3 main phases:

phase 1: in this initial phase the deformation occurs at the highest rate and lasts for 3-5 days / on average 100 hours.

phase 2: the rate of deformation becomes constant, the deformations show a linear increase as a function of time and last for 5 - 30 years

phase 3: creep will stop or slow down to a negligible degree



- from 16 to 40 mm in diameter: boring machine with guide tip and cutting edge
- Boring machines with a diameter from 1.5 to 16 mm can be used with excavation devices having a hard metal tip.

Milling

It is recommended, also for these operations, to use milling machines with carbide tips. Reversible blade set of milling machines ensure quick replacement and high accuracy. ($n_{\min} = 22000 \text{ min}^{-1} = 367 \text{ s}^{-1}$)

Sanding

Edge irregularities can be eliminated by sanding. The recommended dimensions for the sandpaper grit are: 60 - 80. An appropriate depth of cut can be reached with the use of belt sanders. Dust extraction should be ensured in all circumstances. ($v = 350 \text{ m/min}$)

Fixing with nails and clamps

BetonWood® pre-drilled panels can be nailed using manual methods but the use of screws is always preferable. Their fixing to natural wood can only be carried out by means of mechanical fixings and pneumatic clamps with automatic drilling. The joints can be significantly improved by using spiral nails.

Fixing with screws

In series production, **BetonWood®** panels can be screwed using electric or compressed air devices (eg nailers, riveting machines). In the assembly of structures, the screw with two screw connections can be used more effectively, as shown in figure 22.

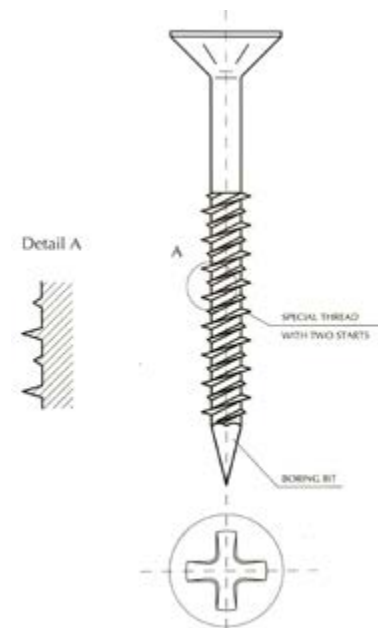

Screw Betonfix NF57

(provided by BetonWood srl)



NF57 galvanized self-tapping screw perfect for fixing outdoor cement bonded particle boards or high density panels on wood or supports with adjustable height (for raised screeds). The special design of the reborded head and the presence of the double-start thread allow a more precise installation.

Screw Betonfix NF60

(provided by BetonWood srl)



NF60 galvanized self-drilling screw with drill bit and self-squeezing underhead for laying, both indoors and outdoors, our BetonWood cement bonded particle boards on metal sheet structures. NF60 screws suitable for fixing MGO sheets, lightweight concrete and cement bonded particle board to sheet metal.



Load capacity conditions

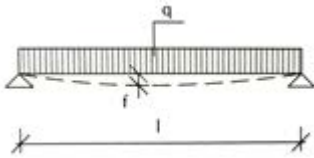

q = uniformly distributed load (kN/m²)
 l = extension (cm)
 f = deformation (mm)

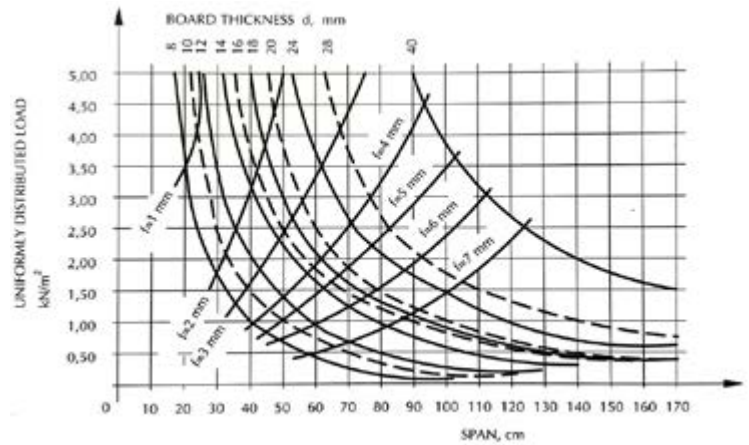
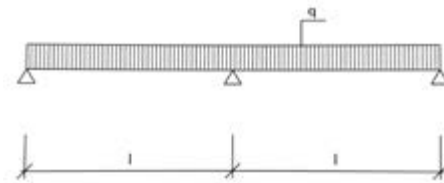

Figure 18 Relationship between load, extension, thickness of the panels and the deformation of the BetonWood® building panels placed on two supports.

Figure 19 Three media loading scheme.



Thickness mm	Uniformly distributed load kN/m ² (1kN x 101,97kg/m ²)							
	1,00	1,50	2,00	2,50	3,00	4,00	5,00	6,00
	Interaxle spacing cm							
8	36	30	26	24	22	19	17	16
10	45	37	33	29	27	24	21	20
12	55	46	40	36	33	29	26	24
14	63	52	46	41	38	33	30	27
16	72	60	53	48	44	38	34	31
18	80	67	59	53	49	43	39	35
20	88	74	65	59	54	48	43	39
22	97	81	72	64	59	52	47	42
24	103	88	78	70	65	57	51	47
28	118	101	89	81	75	66	59	51
32	142	119	104	94	87	76	69	62
36	160	134	118	106	98	86	78	70
40	178	148	130	117	108	95	85	79

Table 5 Distance required to position the panels on three supports according to the thickness of the panels and the distributed load.



Fungi and insect resistance

Tests on cement bonded particle boards performed for resistance to fungi have been performed for decades by the Department of Forest Protection Methods at the University for Forestry and Wood Industry.

Tests were carried out on the panels for their resistance to mold in accordance with the MSZ 8888/9-69 standard. Tests have proved that **BetonWood**[®] panels are “fungicides”.

Tests for resistance to fungi of rotten wood were also conducted in accordance with the MÉMSZ 50 373 standard. In the tests, cultures of *Coniphora cerebella*, *Poria vaporaria* and *Trametes versicolor*, which are the most harmful fungi in the field of building structures, were used: none of the species of fungi have damaged the **BetonWood**[®] panels, therefore, it has been proven that the cement bonded particle boards are “resistant to fungi”. This is confirmed by the results of tests performed by Mutsui Lumber Company, Tokyo.

It has been proven by tests carried out by European institutes that termites do not attack the **BetonWood**[®] cement bonded particle boards even in the phase of acute hunger. BAM, Bundesanstalt für Materialprüfung, Berlin, test result No. 5.1; 4403, 1985. The insect resistance of **BetonWood**[®] panels has also been confirmed by tests conducted at the University of Tokyo, Faculty of Agriculture.

Weather resistance

BetonWood[®] panels are resistant to atmospheric agents, as the wood fibers are protected by the cement against external damage.

The formwork material completely or partially buried in the earth shows no damage during tests carried out for many years. The series of tests conducted by the WoodWorking Research Institute confirms these results. The cement bonded particle boards have been tested by EMPA/Switzerland, 1975/ in a series of measurements consisting of 150 cycles at a temperature of -20°C and +20°C and at a variable humidity level. These tests definitively qualify the panel as frost resistant.

It follows that the **BetonWood**[®] panels without finishing are able to withstand atmospheric agents and extreme stresses.

In the permanent change of relative humidity, effect of direct rain, water and steam cause a change in the moisture content of the panel (see paragraphs on moisture content).

The change in moisture content causes a limited dimensional change.

Dimensional change in plane: at a temperature of +20°C, with a range of relative humidity from 25% to 90%: maximum 0.3%.

In practice: for ±10% variation in the moisture content of the panel: ±2mm/m.

When offering structure, these dimensional variations should be taken into account.

The Quality Control Institute for the Construction Industry obtained the following results by testing the cement bonded particle board in a FEUTRON device for 96 hours in an atmosphere maintained at 60°C temperature and 100% relative humidity.

Thickness bulge 0,92%

Dimensional variations in plan 0,15%

(test result of ÉMI N°. M-34/1975)



Nail tightness on BetonWood®

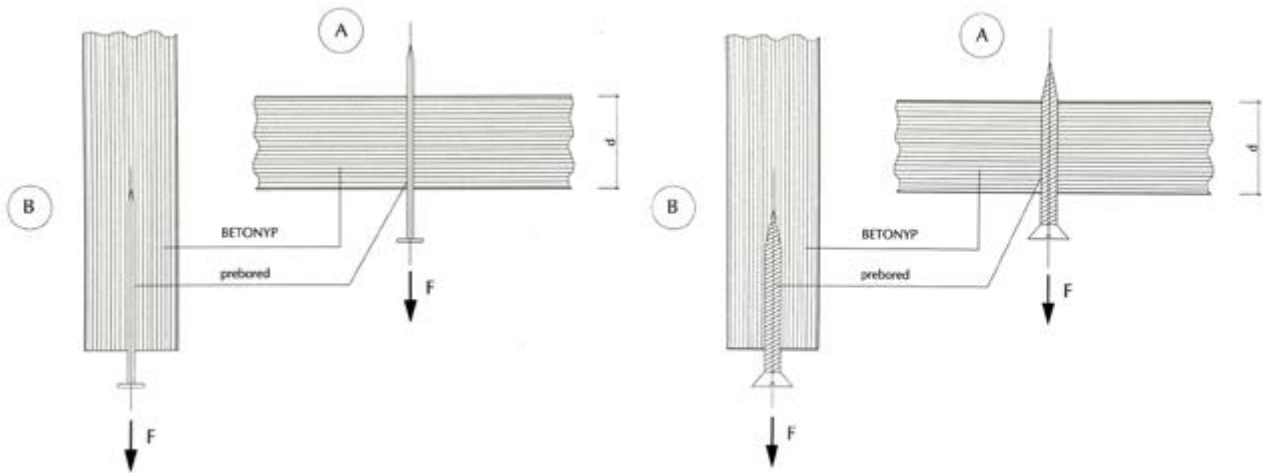

Figure 20 Test scheme for tightness of nails and screws.

Nail used for the test: 30 x 3 mm Degree of pre-drilling: $0,8 d_{sz}$

Fixing direction on panel	Thickness mm		
	12	18	24
A (perpendicular to the plane of the panel)	39,2	51,9	81,4
B (parallel to the plane of the panel)	12,7	36,3	23,5

Table 6 Nail tightness values for BetonWood® panels

Screw tightness on BetonWood®

Fixing direction on panel	Thickness mm		
	12	18	24
A (perpendicular to the plane of the panel)	96,1	136,3	158,9
B (parallel to the plane of the panel)	49,0	75,5	90,2

Table 7 Screw tightness values for BetonWood® panels

Screw used for the test: 40 x 4 mm in accordance with the requirements of DIN 96 Degree of pre-drilling: $0,8 d_{sz}$

PRE-DRILLING $0,8 d_{sz}$ ALWAYS RECOMMENDED



Processing and fixing of BetonWood® panels

Main principles of processing

The processing of **BetonWood®** requires the use of tools with a carbide tip. Traditional hand tools (iron, chrome-vanadium) can also be used although, in this case, wear will be greater. Manual processing is facilitated by the use of metal saws or metal boring machines (recommended to improve dust extraction while working the panels).

The minimum suction speed should be 30m/s.

Cut on measure

The use of carbide tipped saws is recommended. The cutting depth should be adjusted so that the saw blade protrudes slightly (3-8 mm) from the **BetonWood®** panel.

An excellent quality of the edges, an increase in the durability of the same and a low cut resistance can be obtained using a saw with carbide serrated blades as shown in figure 21. Blades with other shapes can also be used taking into account that the durability of the border will be reduced.

($n_{\min} = 4500 \text{ min}^{-1} = 75 \text{ s}^{-1}$)

Grooves cutting

The use of carbide tipped saws is recommended. ($v = 1.5 - 6 \text{ mm}$).

($n_{\min} = 5300 \text{ min}^{-1} = 88 \text{ s}^{-1}$)

Circular cut and other cut's types

An electric compass can be used to cut holes with a diameter larger than 30 mm as well as for cutting other shapes and for cutting corners.

($n_{\min} = 1600 \text{ turns/min}$)

Drilling

High speed steel boring machines with standard carbide tipped tools are recommended for this operation.

($n_{\min} = 400 \text{ W}$; $n_{\min} = 1200 \text{ min}^{-1} = 20 \text{ s}^{-1}$)

Boring machines with maximum revolutions per minute can create cleaner holes. It is recommended to use a piece of solid wood at the exit point of the boring machine. The cutting feed rate should be kept to a minimum.

Types of recommended tools:

- from 1.5 to 16 mm in diameter: twist drill with a cone angle of 60°
- from 8 to 16 mm in diameter: mortiser with guide tip and incision margin

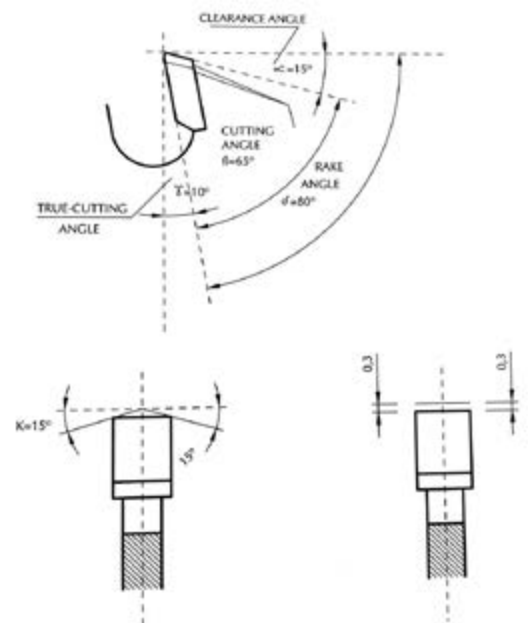

Figure 21

Types of teeth used for cutting **BetonWood®**



Fixing BetonWood® panels

When assembling structures, the following fastening recommendations should be considered:

Fixing with screws	Fixing with nails	Fixing with clamps	Glueing
<p>With pre-drilling. Hole diameter:</p> $D = 0,8 - 1,1 \times D_s$ <p>D_s = screw diameter</p>	<p>Without pre-drilling for panels with a thickness of less than 10 mm. Above this thickness, pre-drilling is recommended.</p> $D = 0,8 D_n$ <p>D_n = nail diameter</p>	<p>Recommended for panels less than 12mm thick only using medium length clamps and appropriate tools.</p>	<p>Provides additional support for nailing and clamping. An alkaline reaction adhesive is recommended.</p>

The cement bonded particle boards must be fixed on a frame carefully.

Figure 23

Distances required for fixing

- figure 23 and table 8 show the distances required for fixing for most of the panels used. The fixing distances at the corners must be selected in order to avoid excessive transverse weakening.
- it is recommended to use a screw fixing for panels with a thickness greater than 16 mm.
- Corrosion resistant frames, galvanized, cadmium-plated, etc. hooks and fixtures must be used.
- Appropriate supports must be provided when attaching panels for any method of assembly.

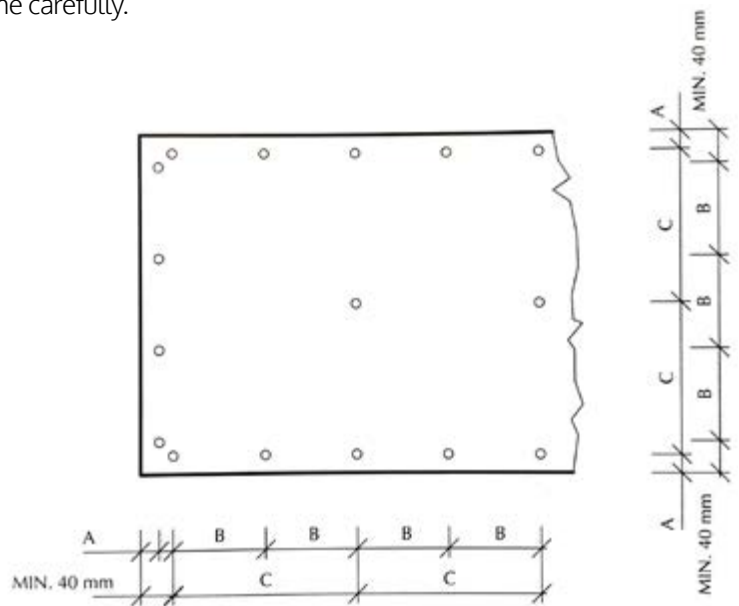

Thicknesses mm	edge A	edge B	edge C
	Fixing distance in mm		
8, 10, 12, 14	20	200	400
16, 18, 20	25	300	600
24, 28	25	400	800
40	40	600	1200

Table 8 Fixing distances according to the thickness of the BetonWood® panels



Joints formation

When designing a **BetonWood®** structure, the following recommendations must be taken into consideration:

- dimensional changes of the components of the structure based on the temperature
- dimensional changes that depend on the moisture content
- load movements on the structure
- external effects, loads (wind pressure, vibrations, etc.)
- fixing elements (type, size, quality, etc.)

When making extensions, the width of the substrate must be suitably selected to ensure that the substrate is reliable.

Visible joints

A wide range of extensions can be made with **BetonWood®** panels using various types of profiles. Some examples are shown in figure 24 and table 9.

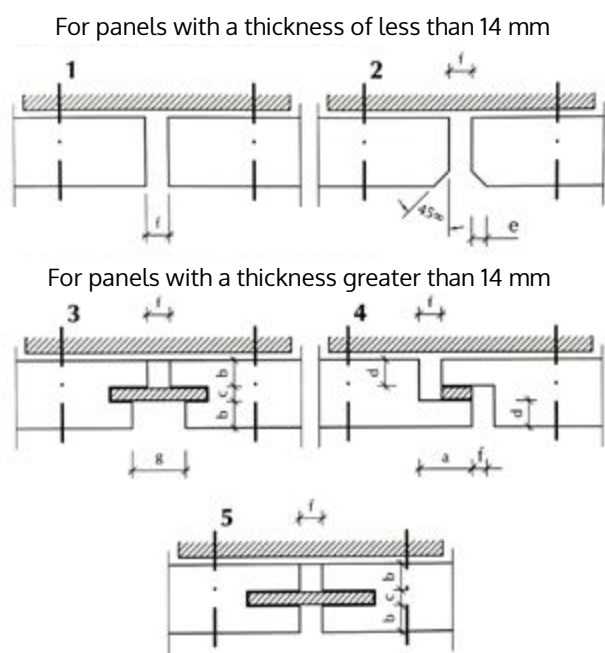

Figure 24
Extensions made with different types of profiles

Simboles	Thickness of BetonWood®		
	until 14 mm	14 - 24 mm	above 24 mm
a	-	11 - 16	max.20
b	-	min. v/2 - 2	min.8
c	-	max. 4	max.8
d	-	v/2 - 0,5	v/2 - 1
e	min.3, max v/3	min.3, max.5	min.3, max. v/4
f	usually 8 - 10 mm depends on the size of the panel		
g	-	usually 2f	usually 2f

Table 9 Dimensions and symbols shown in figure 26 according to the thickness of cement bonded particle boards



The various shapes of the edges are shown in Figures 25, 26, 27 and 28. The extensions can be covered with wood, aluminium or plastic. These are shown in figures 29 and 30.

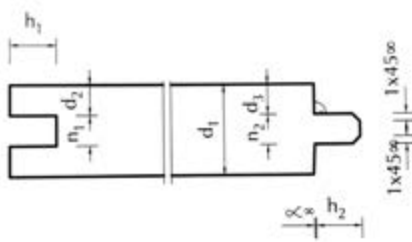

d_1	18	20	24	28	32	36	40
n_2	6	6	8	8	8	8	8
n_1	6,5	6,5		8,5	8,5	8,5	8,5
d_2	6,25	7,25	8,25	10,25	12,25	14,25	16,25
d_3	6,5	7,5	8,5	10,5	12,5	14,5	16,5
γ°	2°	2°	2°	1,5°	1,5°	1,5°	1,5°
h_1	10	10	10	10	10	10	10
h_2	8,5	8,5	8,5	8,5	8,5	8,5	8,5

Figure 25 Tongue&groove profile. Min.thickness 18 mm

Invisible joints

When creating a surface without joints, the external and internal perimeter needs different procedures.

- It is customary to use plasterboard panels screwed directly onto **BetonWood®** on internal walls and false ceilings.
- On the external walls, on the other hand, it is recommended to use fiberglass mesh and smoothing compound.

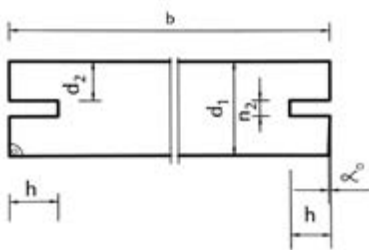

d_1	16	18	20	24	28	32	36	40
n_2	3,5	3,5	3,5	3,5	3,5	3,5	3,5	3,5
d_2	5,5	6,5	7,5	9,5	11,5	13,5	15,5	17,5
γ°	2°	2°	2°	1,5°	1,5°	1,5°	1,5°	1,5°
h	10	10	10	10	10	10	10	10

Figure 26 Tongue&groove profile. Min.thickness 16 mm

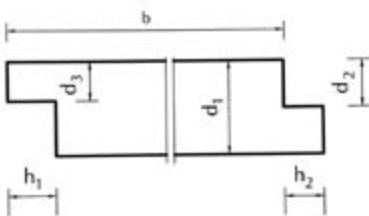

d_1	12	16	18	20	24	28	32	36	40
d_3	5,5	7,5	8,5	9,5	11,5	13,5	5,5	17,5	19,5
d_2	5,8	7,8	8,8	9,8	11,8	13,8	15,8	17,8	19,8
h_1	10	10	10	10	10	10	10	10	10
h_2	9	9	9	9	9	9	9	9	9

Figure 27 Battened profile. Min.thickness 12 mm

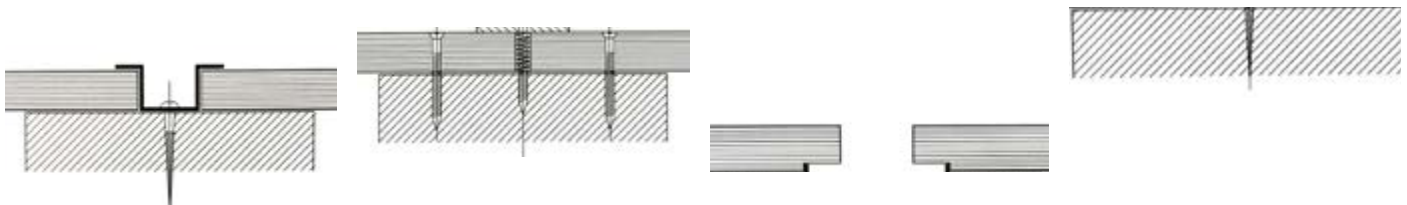

Figure 28 Joints

Drilling of BetonWood® panels

Before choosing and applying the adhesive on **BetonWood®** panels, it is highly recommended to ask for technical information from the adhesive supplier.

Finishing and painting

For the finishing of **BetonWood®**, the following recommendations should be considered:

- thanks to its considerable cement content, the panel shows alkaline reactions;
- the surface of the panel is smooth and quite absorbent;
- the moisture content should not exceed 14%.

Due to the alkalinity of the panel, alkali-resistant materials should be used for finishing **BetonWood®** panels and an alkali-resistant base coat should be applied.

What is priming for:

- to reduce surface alkalinity
- to make the absorbency uniform
- to reduce the absorption of moisture

So-called alkali-resistant primers can be used for this purpose. Before applying the finishing materials, it is highly recommended to ask our office for technical information.

BetonWood® panels are suitable for use in thermal insulation systems. After fixing the panels to the support structure (X-Lam or metal) and filling the joints with Beton Elastic elastic cement mortar, proceed with the laying of the BetonNet Glass 360 fiberglass mesh and smoothing with Beton AR1.

For painting consult the products in the price list or ask our [technical office](#).

Building solutions

Cement bonded particle boards on metal frame structures

BetonWood srl provides complete systems of natural insulation with high performance and high thermal displacement for walls, roofs, ceilings and screeds with cement bonded particle board fixed on metal structures.

We recommend consulting the installation instructions. Once the **BetonWood N®** type panels have been positioned on a metal structure with a center distance (whose dimensions will depend on the panels) they will be arranged in a staggered manner and screwed. The arrangement of the screws is indicated on p. 48, follow the instructions as shown in Figure 23 and Table 8.

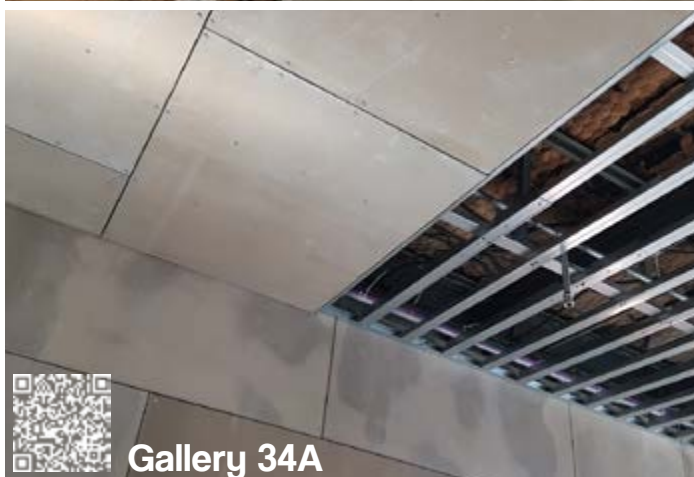
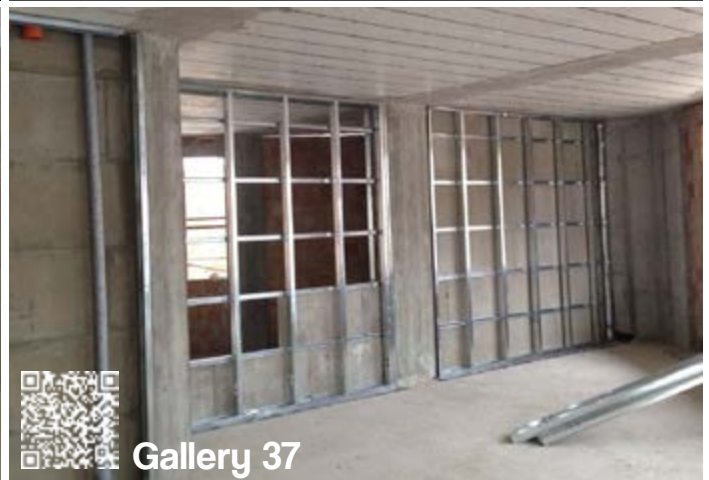
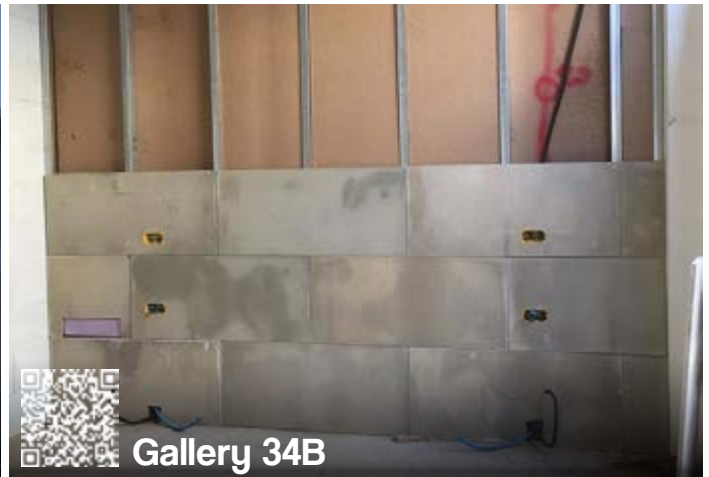
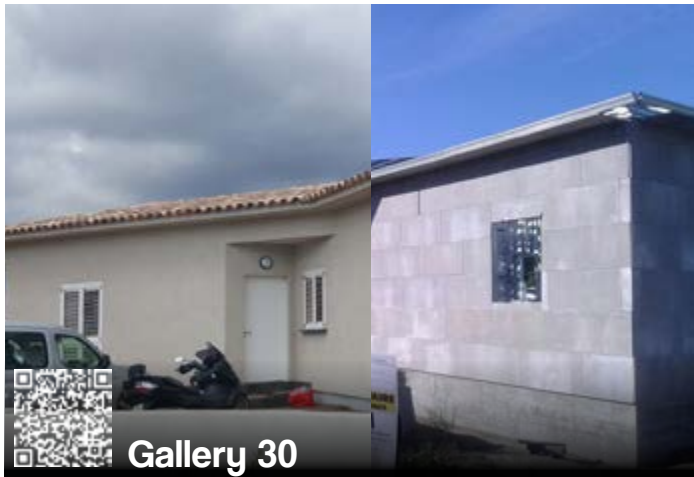

Cement bonded particle boards on wood frame structures, OSB, X-Lam

BetonWood srl provides complete systems of natural insulation with high performance and high thermal displacement for walls, roofs, ceilings and screeds with cement bonded particle board fixed on wooden structures, X-lam, Osb 3.

We recommend consulting the installation instructions. Once the **BetonWood N®** type panels have been positioned on a wooden structure with center distance (whose dimensions will depend on the panels) they will be arranged in a staggered manner and screwed. The arrangement of the screws is indicated on p. 48, follow the instructions as shown in Figure 23 and Table 8.

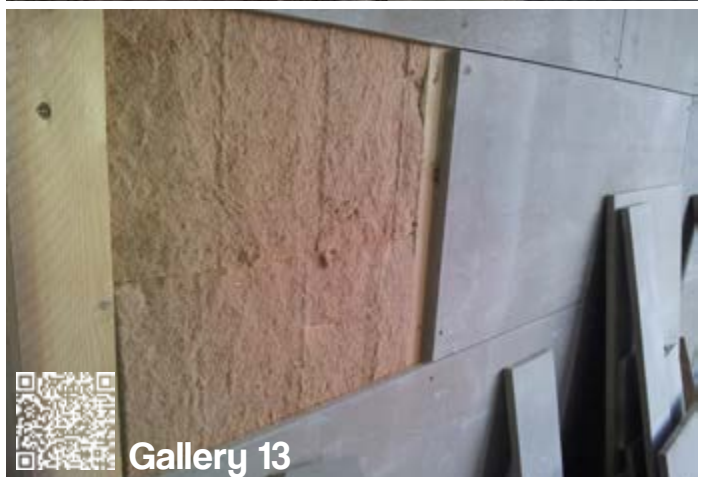
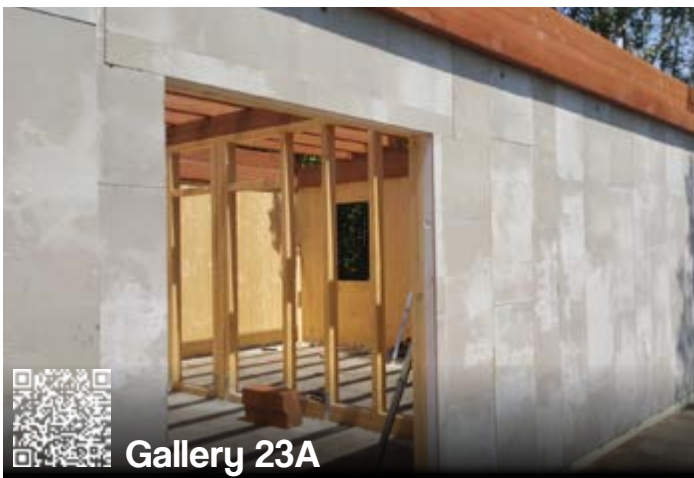
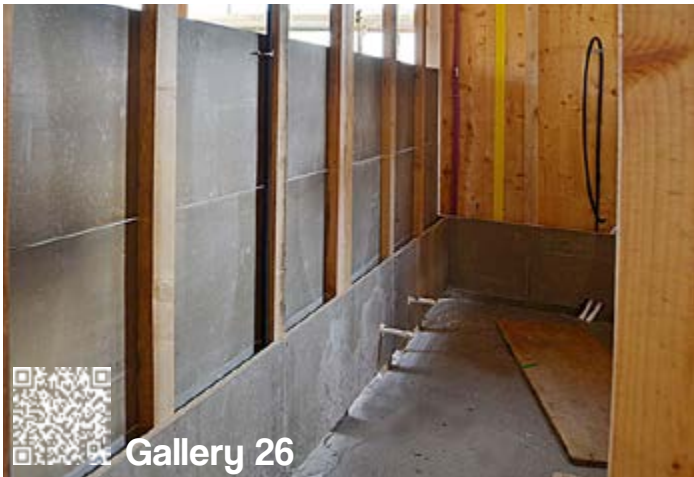

Cement bonded particle boards on dry screeds

BetonWood srl provides a whole series of construction systems for dry and wet screeds, external and internal, traditional and raised, using **BetonWood®** cement bonded particle products and natural insulating materials in **Fibertherm®** wood fiber and/ or **CorkPanels** blond cork.

Thanks to **BetonWood®** dry screed panels it is possible to create high quality floors in a rational way and with the dry technique. **BetonWood®** panels are comparable to traditional screed systems, with the advantage of a light weight and a faster assembly method.

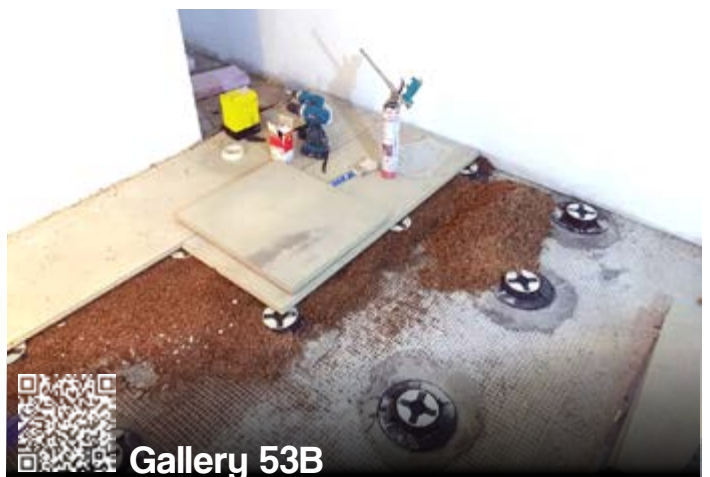
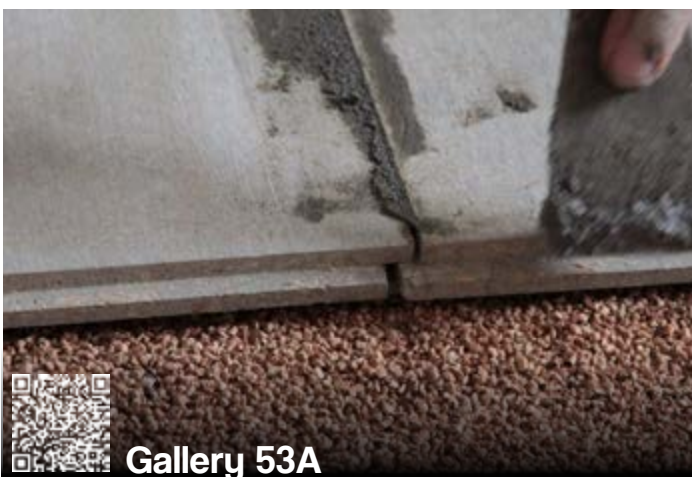
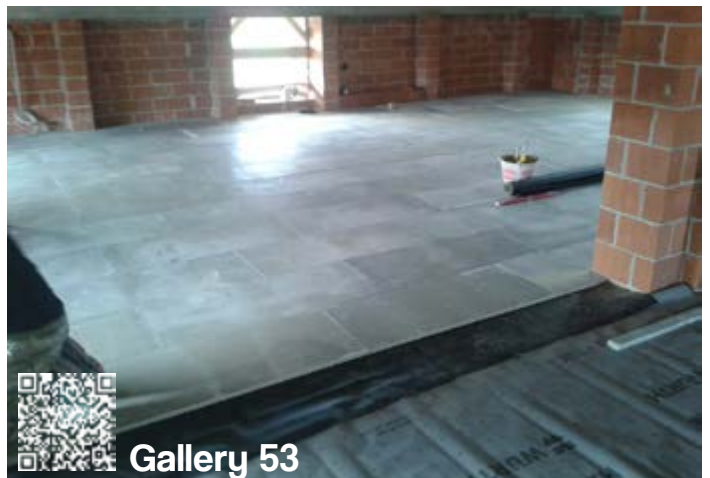
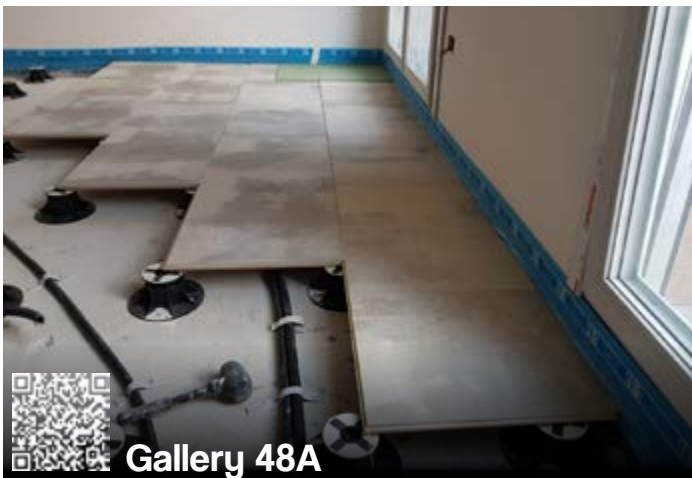
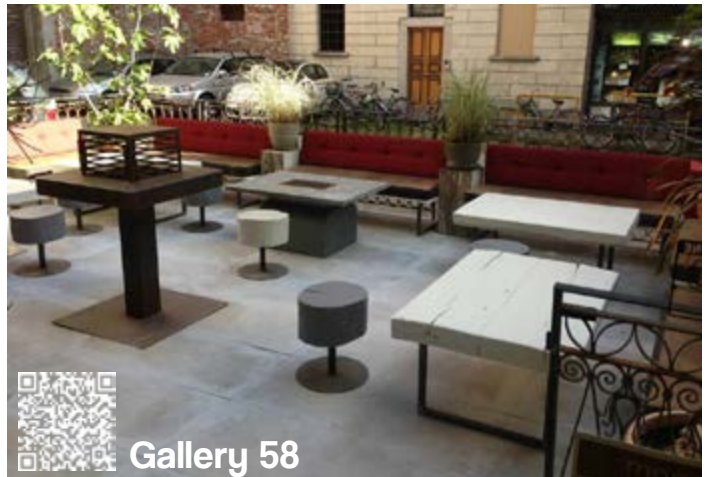
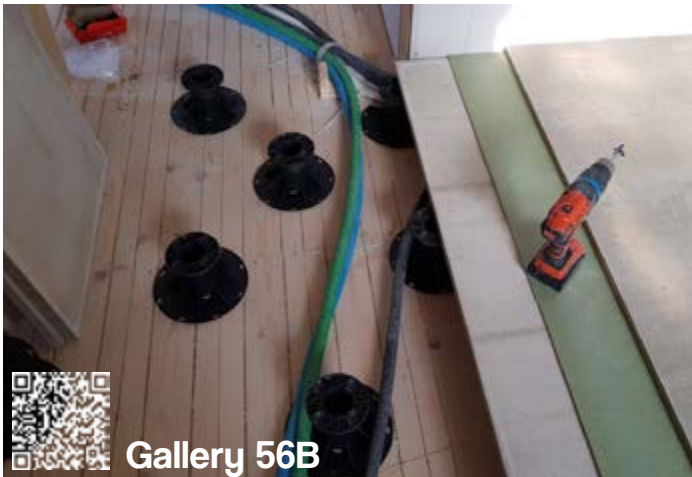

Cement bonded particle boards on corrugated metal sheet

The combination of **Beton metal sheet®** and **BetonWood®** panels will act as a composite panel and will guarantee a system for dry screeds, walls and roofs with a great compressive strength equal to 10 kN/m² with an interaxle distance of 1000mm.

The system is made up of **BetonWood®** panels laid in the same direction as **Beton metal sheet®**.

Beton metal sheet® is fixed with self-drilling screws type NF60 to the frame profiles. Between the two layers it is possible to lay insulating layers of wood fiber or blond cork from our range.

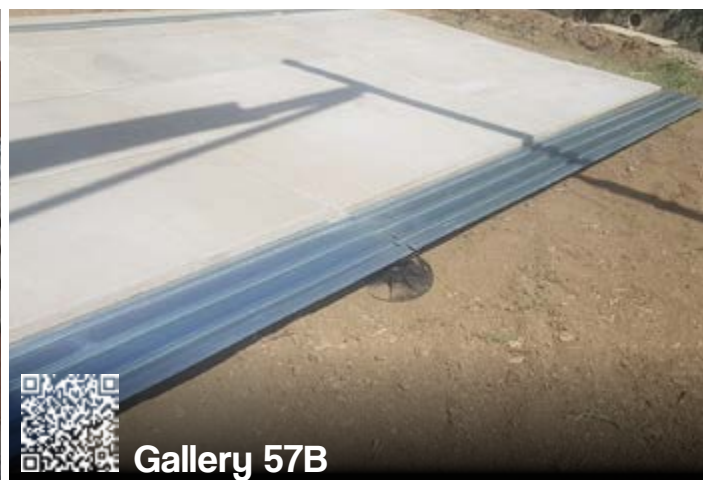
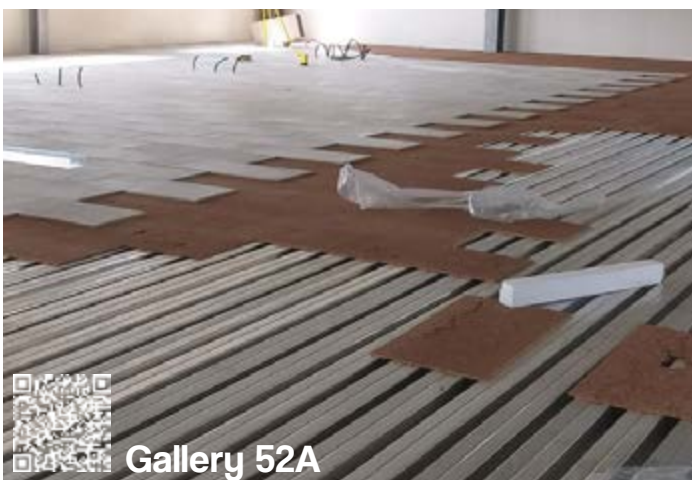
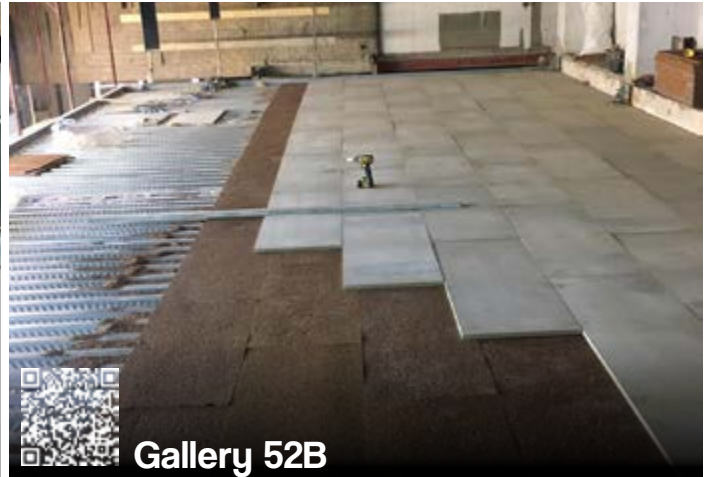

Cement bonded particle boards for roofs

The **BetonWood**® panels can also be used in roof systems in the form of couplings (such as BetonFiber, BetonCork, BetonStyr, Betonwall) or, separately, with highly insulating panels in **FiberTherm**® wood fiber or **CorkPanels** blond cork.

Our cement bonded particle boards are suitable for use not only in traditional roof systems with high thermal displacement, but also in systems for ventilated roofs thanks to suitable height-adjustable supports.

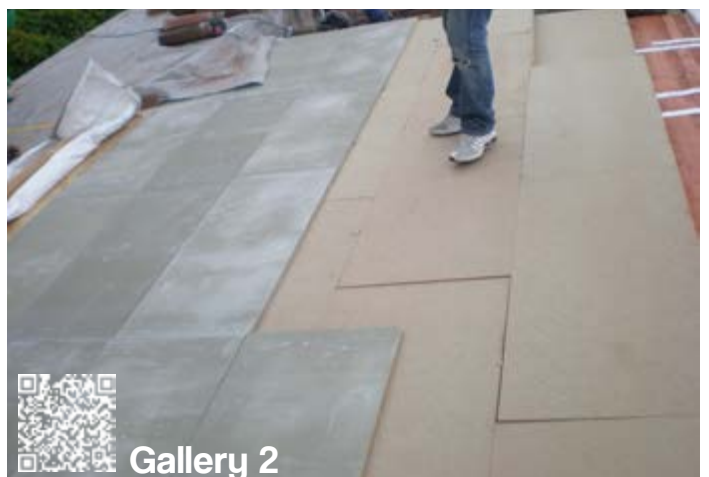
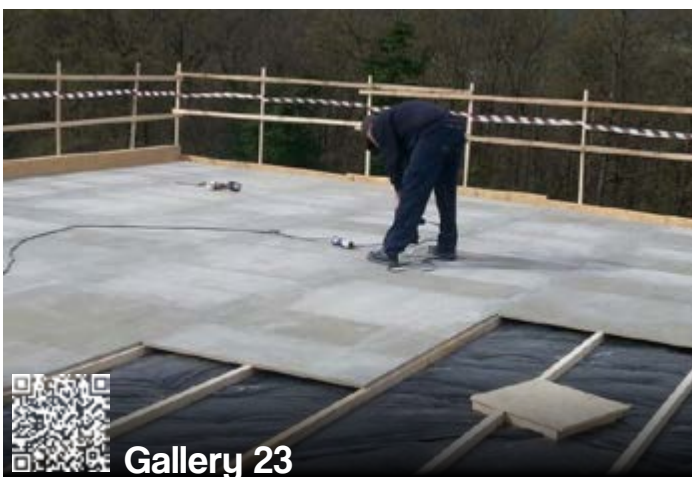
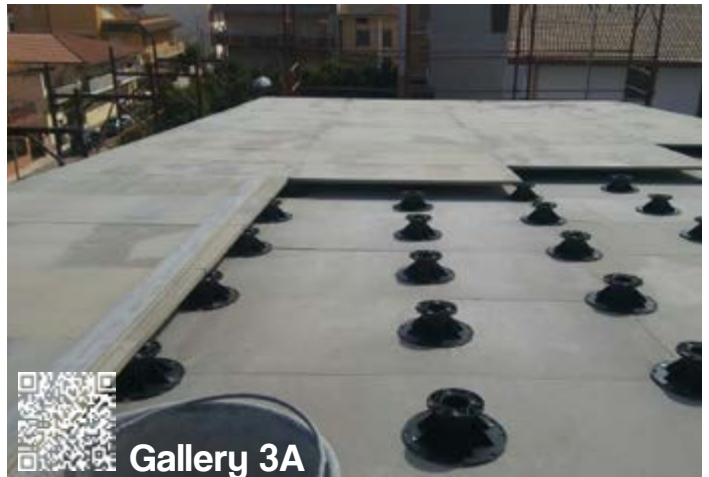
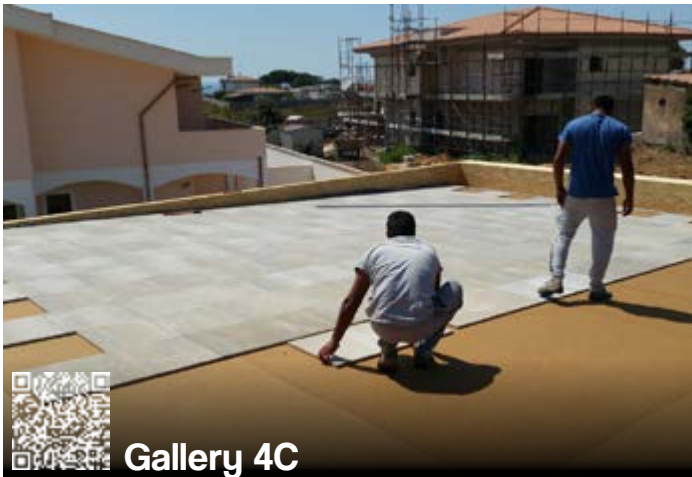

Cement bonded particle boards for walls and counter-walls

The **BetonWood®** cement bonded particle boards can be used on external and internal facades, walls or counter-walls, even exposed, fixed on metal, wood or sheet metal structures.

On **BetonWood®** panels, coatings other than simple smoothing can be applied; in fact, both indoors and outdoors, ceramic or stone tiles can be easily installed directly on the surface.

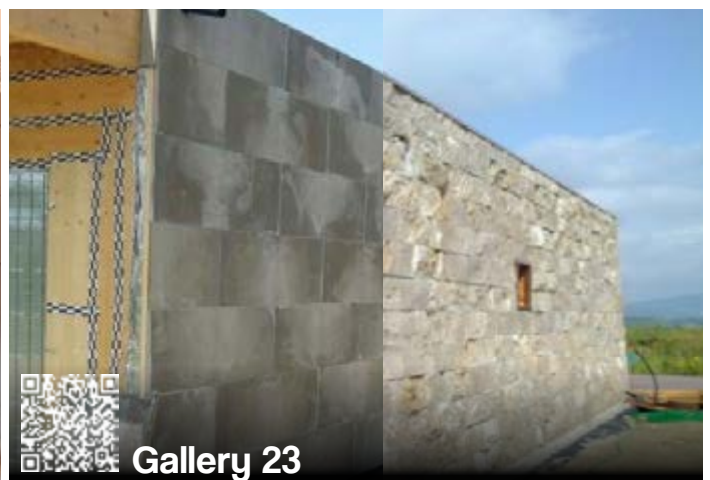
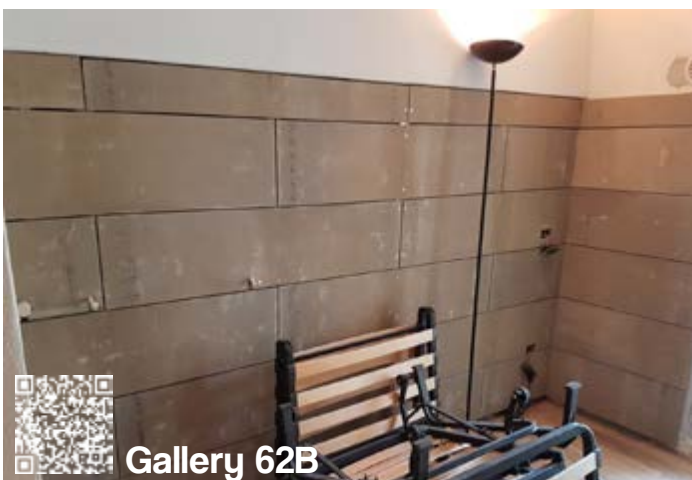
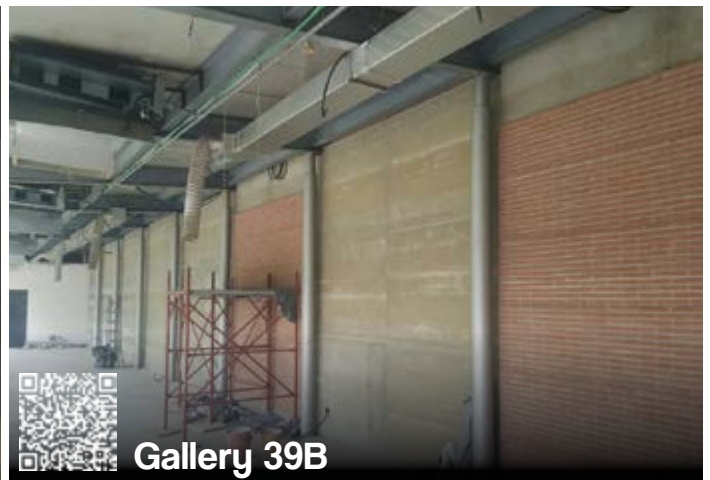
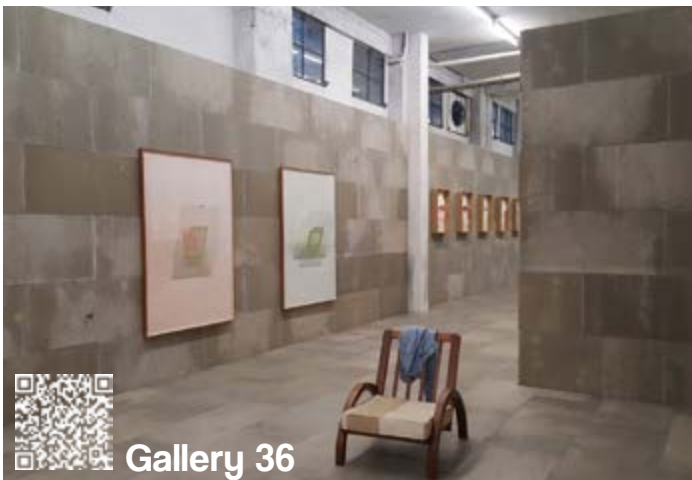
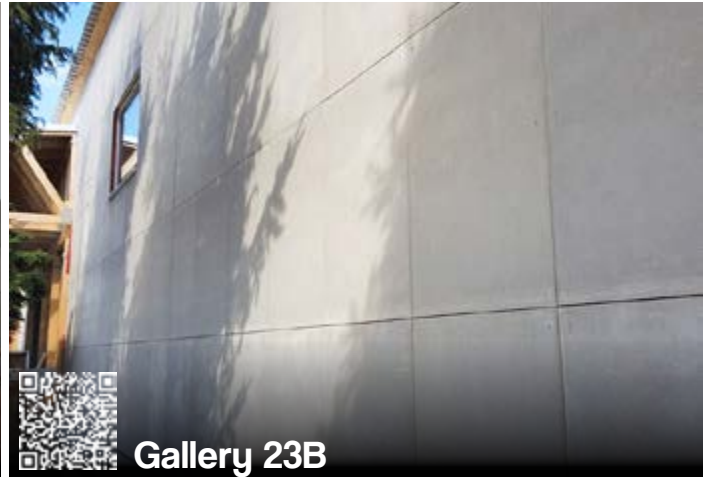
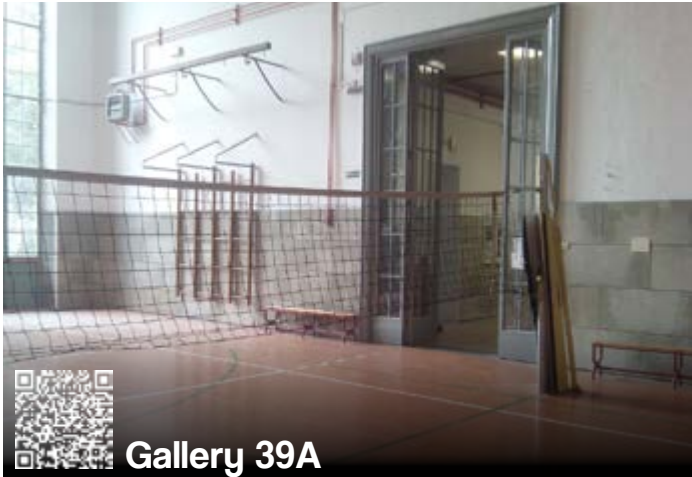

Cement bonded particle boards for radiant heating systems

Betonradiant® is a modular system in cement bonded particle board for the construction of radiant floors which is an excellent solution for having a radiant floor heating system with condensing boilers.

The high performance radiant heating system can also be used on ceiling systems, internal walls and floating screeds.



Gallery 48

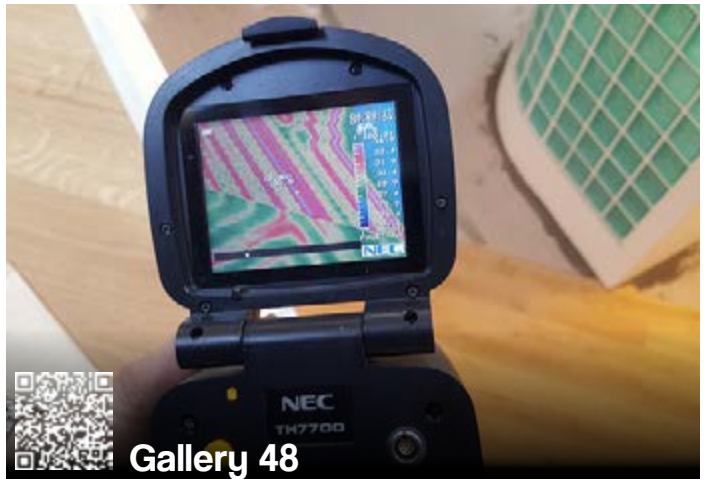

Gallery 48



Gallery 44

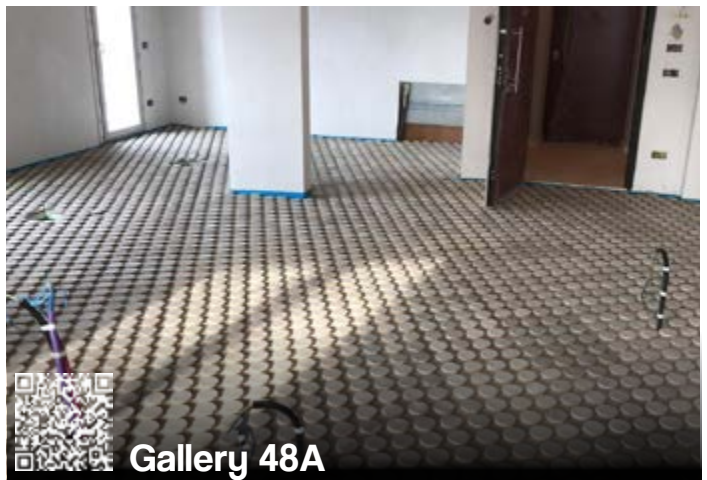

Gallery 48A

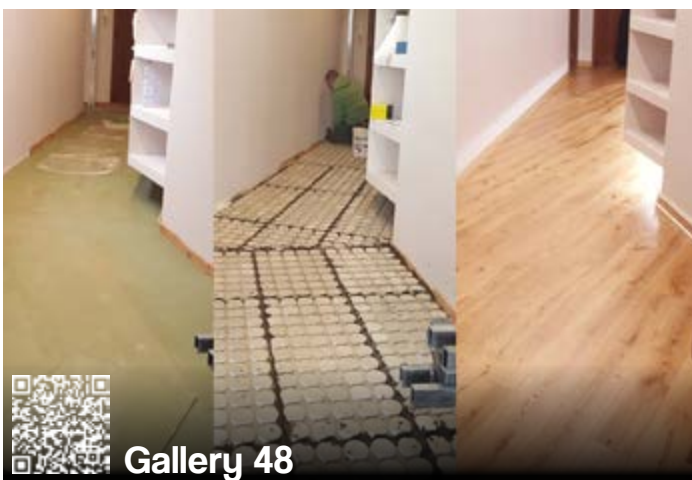

Gallery 48



Gallery 48

Cement bonded particle boards for exhibitions and interiors

The **BetonWood®** panels thanks to their aesthetic characteristics they are also widely used for permanent or temporary installations; in fact, thanks to their ease of installation, without the need for specialized labor, they are also very quick to dismantle. They are therefore widely used in fairs, stands, museum fittings, stages for fashion shows, permanent shop fittings such as Nike and Colmar.

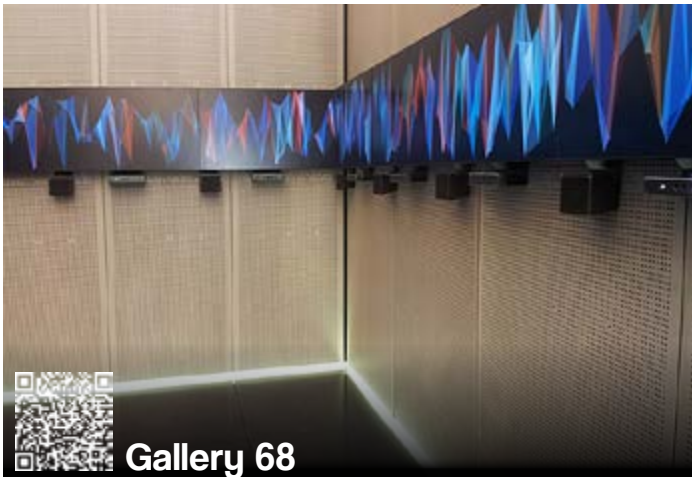

Gallery 68



Gallery 70



Gallery 65



Gallery 73



Gallery 56A

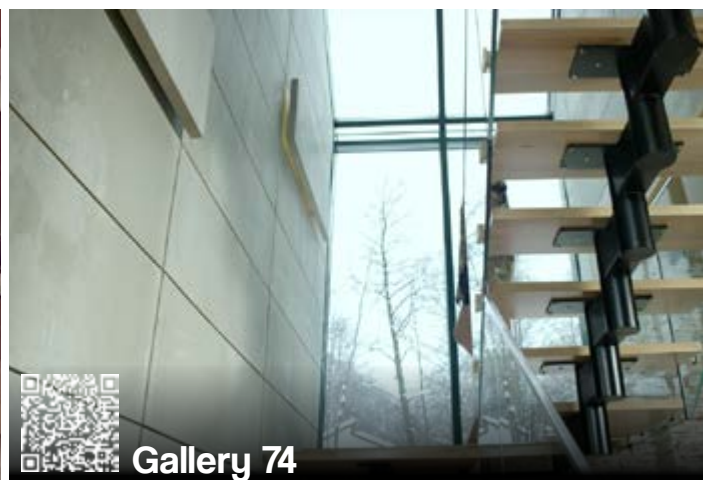

Gallery 74

Useful notes

30 years of BetonWood®

Cement and debarked pine wood: the raw materials used to produce one of the most successful products in the field of green building for more than three decades. Our cement-bonded particleboard, called BetonWood®, is used where a lightweight yet tough and resistant construction is required.

- high resistance to abrasion and impact
- resistance to humidity and frost
- resistance to fungi and insects
- flame resistance and anti-combustion
- free of toxic substances such as formaldehyde and asbestos
- ease of processing and fastening
- long duration
- natural, sustainable and recyclable material

Certified building material



BetonWood srl

Via di Rimaggio, 185
I-50019 Sesto Fiorentino (FI)
T: +39 055 8953144
F: +39 055 4640609
info@betonwood.com
www.betonwood.com

The indications and requirements indicated above are based on our current technical and scientific knowledge, which in any case are to be considered purely indicative, as the conditions of use are not controllable by us. Therefore, the buyer must in any case verify the suitability of the product for the specific case, assuming all responsibility for use, relieving BetonWood® from any consequent claim for damages.

For any information, contact our sales department at:

info@betonwood.com

SELL TERMS AND CONDITIONS: downloadable on the site www.betonwood.com